

Spring 2026

Pondkeeper



SPRING Sale

NEW



Solar Air Pumps
see pg 83

NEW



SteriClear UVC
see pg 76

NEW



Non-Stop 3 Pond Vac
see pg 73



Free SOLAR POND LIGHT worth **£19.99***



***Free Solar Pond Light** (product details see pg 105) on orders over £40 - quote code **SALE26** to qualify

pondkeeper.co.uk | 01642 370888

Open Now
Best **EVER** Deals
Inside

Solar Specials 2026

Solar Oxygenators & Fountains with clever features: NEW

- Lithium battery
- Remote control option
- USB charging



NEW

PondXpert SolaFlow
Solar Fountains
See pg 43

NEW

PondXpert SolaOxy
Solar Oxygenators
See pg 83

EXCLUSIVE! Solar Pump with UV filter & Battery

For the first time small ponds can achieve clear healthy water without the need for mains electricity!

UVC PUMP FILTER

PondXpert Solar TripleAction 'all in one' pumps introduced the world's first solar pond UVC in 2023. Enabling small ponds to be clear of green water.

A bestselling item now available with up to 15% discount!

- Allows pond to be positioned remotely (mains power not required)
- Eco-friendly, zero running costs

Solar TripleAction 800 Was £149.99 **SALE PRICE £129.99**

Solar TripleAction 1600 Was £199.99 **SALE PRICE £169.99**

NEW **Solar TripleAction 1200 Hybrid** Solar energy/Mains power auto switch **£119.99**

See pg 45

800 & 1600 models have lithium battery. New 1200 Hybrid model designed to be connected to mains (no battery inc.), solar when sunny.

Welcome to your copy of our **Super Spring Catalogue.**

With a lot of uncertainty in the world today it's good to have a hobby that brings joy and peace of mind.

Pondkeeping is always its most rewarding at this time of year and we hope you will find a few interesting new ideas inside.

Director, Founder & Proud Pondkeeper
Stephen Armstrong

Your feedback is greatly appreciated. We now have over **5000 products** reviewed & rated on our website. This helps newcomers to the hobby to decide what to buy and lets us know what products to keep in our range. Also, your comments regarding your buying experience with us help us to maintain a high level of service.



Over 29,500 customer reviews now shared online. We recently received a Platinum Trusted Service 2024 award. Awarded for achieving Gold Trusted Service for the past three consecutive years.



* Reviews correct at time of going to press



Contents	Page
POND FILTRATION SETS	4-9
PREFORM/RAISED PONDS	10-15
PEBBLE PONDS	16
FISH VIEWING TOWERS	17
POND LINERS	18-24
WATERCOURSES	25-29
POND PUMPS	30-53
All-in-One	30-33
Feature/Fountain	34-36
Solar Pumps	37-45
Solar Water Features	46-47
Filter Pumps	48-53
POND FILTERS	54-64
Gravity/Box Filters	55-57
Pressure Filters	58-61
Koi Filters	62-64
PONDSIDE ELECTRICS	65
CLEANING TOOLS	66-74
Pond Vacuums	71-74
UV UNITS & BULBS	75-77
POND AIR PUMPS	78-83
HERON DETERRENT	84-85
WATER TREATMENTS	86-95
FISH FOOD & FEEDERS	96-100
ORNAMENTAL CREATURES	101
POND LIGHTING	102-105
POND PLANTS	106-110
HOSE & FITTINGS	111-114
SHED ROOFING KITS	113

So Easy To Order



Online

Secure 24/7 ordering
www.pondkeeper.co.uk



Phone

Our friendly team are ready to take your order **01642 370888**

8am - 6pm March to September 30th.
9am - 5pm October to February.

Visit/Shop

Sales counter in Billingham near Middlesbrough. Drop in anytime.

Now Open Sat. 9-5 & Sun. 10-4

Weekends Spring/Summer only

Post

Cheques or credit card numbers to:
Pondkeeper, A3 Bentley Avenue,
Billingham. TS23 4BU

Make payable to 'pondkeeper'

Claim Your Special Offer

Quote code on cover to trigger offer.

*Minimum spend excludes P&P. Offers expire 31/07/26. Not to be used in conjunction with any other offers.



EasyPond Sets

Box Filter Sets

The Classic Filtration System



The easy way to buy your pond hardware

Save up to £306.66*

Pump supplied different to image, see table below

COMPLETE FILTER SYSTEMS - everything you need
Filter Pump, Pond Hose, UVC Filter, Clips



Model	Filter Model Size	Pump Size LPH	Usual Price*	OUR PRICE	Save	Pond Dimensions			Complete Kit	
						L (m/ft)	W (m/ft)	D (m/ft)	Liner & Underlay	SALE PRICE
EasyPond Box 6000	6000	2000	£173.46	£139.99	£33.47	3.7 / 12'	2.5 / 8'	0.6 / 2'	5 x 5m	£229.99
EasyPond Box 8000	8000	2500	£208.46	£159.99	£48.47	4.0 / 13'	3.0 / 10'	0.6 / 2'	6 x 5m	£269.99
EasyPond Box 12000	12000	6200	£258.46	£199.99	£58.47	5.0 / 16'	4.0 / 13'	0.6 / 2'	7 x 6m	£329.99
EasyPond Pro 9000	9000	6000	£433.45	£309.99	£309.46	3.0 / 10'	3.0 / 10'	1.0 / 3'	6 x 6m	£449.99
EasyPond Pro 18000	18000	10000	£573.45	£429.99	£429.46	5.0 / 16'5"	3.0 / 10'	1.0 / 3'	8 x 6m	£619.99
EasyPond Pro 36000	16000	16000	£713.45	£539.99	£539.46	7.0 / 23'	5.0 / 16'	1.0 / 3'	10 x 8m	£869.99

Components Supplied

EasyPond Box 6000: **Pump** - PondXpert MightyMite 2000 (pg 48) **Filter** - PondXpert FiltoBox 6000 with 9W UVC (pg 57)

EasyPond Box 8000: **Pump** - PondXpert MightyMite 2500 (pg 48) **Filter** - PondXpert FiltoBox 8000 with 9W UVC (pg 57)

EasyPond Box 12000: **Pump** - PondForce 6200 **Filter** - PondXpert FiltoBox 12000 with 18W UVC (pg 57)

All Sets include 25mm (1") Pond Hose x 5m (16') plus a pair of 25mm clips. Liner Sets include Flexiliner 40yr plus Basic Underlay.

EasyPond Box Pro



MultiChamber 9000



MultiChamber 18000



GreenStop PRO 36W UVC



MultiChamber 36000



EasyPond Box PRO Sets Components Supplied

EasyPond Box PRO 9000: **Pump** - PondXpert UltraFlow 6000 (pg 49) **Filter** - PondXpert MultiChamber 9000 with 36w UVC (pg 64)

EasyPond Box PRO 18000: **Pump** - PondXpert UltraFlow 10000 (pg 49) **Filter** - PondXpert MultiChamber 18000 with 36w UVC (pg 64)

EasyPond Box PRO 36000: **Pump** - PondXpert UltraFlow 16000 (pg 49) **Filter** - PondXpert MultiChamber 36000 with 36w UVC (pg 64)

All Sets include 25mm (1") Pond Hose x 5m (16') plus a pair of 25mm clips. Liner Sets include Flexiliner 40yr plus Fleece Underlay.

EasyPond Sets

Pressure Filter Sets

Maximise your landscaping options

Save up to £216.13*



The Best Value Entry - Level Systems

If you are looking for extra features simply turn the page . . .

Add a Pond Liner to Set **SAVE even more!**

Pump and filter sets

Exclusive

* Cost of buying set products individually

Complete Pond Kits

Model	Filter Model Size	Pump Size LPH	Usual Price*	SPECIAL PRICE	Pond Dimensions			Volume		Liner and Underlay	Usual Price*	SPECIAL PRICE
					L (m/ft)	W (m/ft)	D (m/ft)	Litres	Gallons			
EasyPond 2000	4500	2000	£177.95	£109.99	2.0 / 6' 6"	1.7 / 5'6"	0.6 / 2'	2040	450	4 x 3m	£235.43	£159.99
EasyPond 3000	4500	2300	£182.95	£119.99	2.5 / 8'	2.0 / 6'6"	0.6 / 2'	3000	660	4 x 4m	£259.59	£184.99
EasyPond 4500	4500	3000	£192.95	£129.99	3.4 / 11'	2.2 / 7'3"	0.6 / 2'	4488	1000	5 x 4m	£288.75	£209.99
EasyPond 7000	9000	3000	£237.95	£154.99	3.4 / 11'	3.4 / 11'	0.6 / 2'	6936	1500	5 x 5m	£357.70	£264.99
EasyPond 8000	9000	4700	£247.95	£164.99	4.0 / 13'	3.4 / 11'	0.6 / 2'	8160	1800	6 x 5m	£391.65	£289.99
EasyPond 9000	9000	6200	£297.95	£189.99	3.0 / 10'	3.0 / 10'	1.0 / 3'	9000	2000	6 x 6m	£470.39	£344.99
EasyPond 10000	12000	6200	£327.95	£219.99	3.3 / 11'	3.0 / 10'	1.0 / 3'	9900	2200	6 x 6m	£500.39	£369.99
EasyPond 12000	12000	8000	£347.95	£234.99	4.0 / 13'	3.0 / 10'	1.0 / 3'	12000	2500	7 x 6m	£549.13	£399.99
EasyPond 15000	15000	10000	£398.95	£279.99	4.0 / 13'	4.0 / 13'	1.0 / 3'	16000	3500	7 x 7m	£636.66	£499.99
EasyPond 20000	20000	12000	£458.95	£319.99	4.5 / 15'	4.5 / 15'	1.0 / 3'	20250	4500	7.5 x 7.5m	£728.39	£549.99

Choose the Right Pond for your Garden

EasyPond Depths & Fish Stocking Information

Smaller Sets (EasyPond 2000-8000) suggested max. depth 60cm (2 ft). Ideal ornamental or goldfish ponds.

Larger Sets (9000-20000) suggested max. 1m (3' 3") depth. Suitable for higher fish levels and/or koi.

There are no limits to a pond size. This information is given as a guide only. For other pond sizes please get in touch with your dimensions and we can help.

Pump Detail All handle solids and can run 24/7.

Set Name	Pond Pump Included
EasyPond 2000	PondXpert MightyMite (pg 48)
3000-10000	PondForce Pump (pg 115)
12000-20000	PondXpert UltraFlow (pg 49)

Liner & Underlay Detail

Liner Sets Include Flexiliner 40yr and Basic Underlay

Hose & Clips Detail

Sets include 5m pond hose & 4 x clips 25mm

Filter Detail 2000-12000 PondXpert EasyFilter (pg 58)
15-20000 PondHero Turn2Clean (pg 58)



Includes all hose, clips and fittings



EasyPond 2000

← 6.5 ft →

↓ 2 ft



EasyPond 3000

← 8 ft →

↓ 2 ft



EasyPond 4500

← 11 ft →

↓ 2 ft



EasyPond 7-8000

← 10-13 ft →

↓ 2 ft



EasyPond 9-12000

← 10-13 ft →

↓ 3 ft



EasyPond 15000

← 14 ft →

↓ 3 ft



EasyPond 20000

← 15 ft →

↓ 3 ft

EasyPond Plus Sets

Pressure Filter Sets

Maximise your landscaping options

- Perfectly matched components!
- Save £££'s



The **Secret** Behind every Successful Pond . . .



. . . is selecting an effective pump and filter system.



EasyPond Plus Sets

Pressure Filter Sets

Maximum Choice - Maximum Spec - Best Deal!

Taking easy pondkeeping to a new level!

Save up to **£376.13***

Add a Pond Liner to Set
SAVE even more!

Maximise your landscaping options

Pump and filter sets		Exclusive		* Cost of buying set products individually						Complete Pond Kits		
Model	Filter Model Size	Pump Size LPH	Usual Price*	DEAL PRICE	Pond Dimensions			Volume		Liner and Underlay	Usual Price*	DEAL PRICE
					L (m/ft)	W (m/ft)	D (m/ft)	Litres	Gallons			
EasyPond+ 2000	4500	2000	£217.95	£159.99	2.3 / 7' 6"	1.3 / 4' 3"	0.6 / 2'	1794	395	4 x 3m	£275.43	£191.99
EasyPond+ 3000	4500	2500	£222.95	£169.99	2.3 / 7' 6"	2.3 / 7' 6"	0.6 / 2'	3174	699	4 x 4m	£299.59	£215.99
EasyPond+ 4500	4500	3000	£232.95	£179.99	3.2 / 10' 6"	2.3 / 7' 6"	0.6 / 2'	4416	973	5 x 4m	£328.75	£239.99
EasyPond+ 6000	6000	3600	£297.95	£229.99	3.2 / 10' 6"	3.2 / 10' 6"	0.6 / 2'	6144	1353	5 x 5m	£417.70	£299.99
EasyPond+ 8000	8000	5300	£347.95	£259.99	4.0 / 13' 2"	3.3 / 10' 2"	0.6 / 2'	7920	1744	6 x 5m	£491.65	£335.99
EasyPond+ 9000	12000	6000	£397.95	£289.99	3.9 / 12' 9"	3.9 / 12' 9"	0.6 / 2'	9126	2010	6 x 6m	£570.39	£383.99
EasyPond+ 12000	12000	8000	£417.95	£309.99	5.0 / 16' 5"	4.0 / 13' 2"	0.6 / 2'	12000	2643	7 x 6m	£619.13	£419.99
EasyPond+ 20000	20000	12000	£514.35	£369.99	5.4 / 17' 8"	3.6 / 11' 9"	1.0 / 3'	19440	4282	8 x 6m	£744.27	£479.99
EasyPond+ 25000	30000	14000	£644.35	£479.99	5.0 / 16' 5"	5.0 / 16' 5"	1.0 / 3'	25000	5507	7.5 x 7.5m	£913.79	£575.99
EasyPond+ 30000	40000	16000	£734.35	£549.99	6.5 / 21' 3"	4.5 / 14' 9"	1.0 / 3'	29250	6443	9 x 7m	£1036.12	£659.99

Pump/Filter Systems with Best Specification

Save up to **£37%** versus buying items separately!









Our exclusive EasyPond+ Sets are a proven hit with our customers. These new sets are for those customers wanting to utilise features found on the latest equipment.

Introducing EasyPond+ Sets

Building on the EasyPond heritage - again a comprehensive range of Sizes to suit every garden. But now the feature count has been extended:

- PondXpert SpinClean Filters boast easyclean technology reducing maintenance.
- PondXpert UltraFlow Pumps boast class-leading performance (6000 set up)
- MightyMite Pumps sets mean easy-clean filtration sets now can be achieved in the smaller ponds at a low prices. (2000 / 3000 / 4500 sets).

Sets include 5m pond hose and 4 clamps. (25mm for smaller systems, 32mm for systems 20000-30000). Flexliner 40yr and Pond Fleece Underlay included in complete kits.

					
EasyPond+ 2000 7'6" x 4'3"	EasyPond+ 3000 7'6" x 7'6"	EasyPond+ 4500 10'6" x 7'6"	EasyPond+ 6000 10'6" x 10'6"	EasyPond+ 8000 13' x 10'	EasyPond+ 12000 16' x 13'
					
EasyPond+ 20000 17' 8" x 11' 9"	EasyPond+ 25000 16' 5" x 16'5"	EasyPond+ 30000 21' 3" x 14'9" 23' x 16' 5" if only 2' deep			

Smaller pond sizes (2000 to 12000 ltrs) based on a max depth of 0.6m (2') Larger set pond dimensions based on 1m depth (3'3")

Feature-Packed Pump & Filter Make pondkeeping a joy not a chore!

Further info on components can be found on the following pages:



- MightyMite Pump - Pg 48
- UltraFlow Pump - Pg 49
- SpinClean Filter - pg 60



Filters with Easy-Clean Technology

EasyPond Auto Sets

Pressure Filter Sets

Maximise your landscaping options

- Perfectly matched components!
- Save £££'s



**"One Touch"
Automatic
Cleaning**



STANDARD SPINCLEAN

EASY
Turn Handle
to Clean

PondXpert SpinClean Filter

- Bestseller
- Unique 'Easy Clean' mechanism
- Highly competitive price point
- Reliable



AUTO SPINCLEAN

Even EASIER!
Simply twist control
dial for motorised
cleaning

PondXpert SpinClean AUTO Filter

- **NEW** Generation with latest technology
- Motorised cleaning process
- Same base features as standard SpinClean
- Additional 'Pro' model for koi-keepers

EasyPond Auto Sets

Pressure Filter Sets

Maximum Choice - Maximum Spec - Best Deal!

Taking easy pondkeeping
to a new level!

Save up to **£567.26***

Add a Pond Liner to Set
SAVE even more!

Maximise your landscaping options

Pump and filter sets		* Cost of buying set products individually								Complete Pond Kits		
Model	Filter Model Size	Pump Size LPH	Usual Price*	DEAL PRICE	Pond Dimensions			Volume		Liner and Underlay	Usual Price*	DEAL PRICE
					L (m/ft)	W (m/ft)	D (m/ft)	Litres	Gallons			
EasyPond Auto 2000	4500	2000	£247.95	£189.99	2.3 / 7' 6"	1.3 / 4' 3"	0.6 / 2'	1794	395	4 x 3m	£305.43	£227.99
EasyPond Auto 3000	4500	2500	£252.95	£199.99	2.3 / 7' 6"	2.3 / 7' 6"	0.6 / 2'	3174	699	4 x 4m	£329.59	£239.99
EasyPond Auto 4500	4500	3000	£262.95	£209.99	3.2 / 10' 6"	2.3 / 7' 6"	0.6 / 2'	4416	973	5 x 4m	£358.75	£251.99
EasyPond Auto 6000	6000	3600	£327.95	£259.99	3.2 / 10' 6"	3.2 / 10' 6"	0.6 / 2'	6144	1353	5 x 5m	£447.70	£311.99
EasyPond Auto 8000	8000	5300	£397.95	£299.99	4.0 / 13' 2"	3.3 / 10' 2"	0.6 / 2'	7920	1744	6 x 5m	£514.65	£359.99
EasyPond Auto 9000	12000	6000	£457.95	£339.99	3.9 / 12' 9"	3.9 / 12' 9"	0.6 / 2'	9126	2010	6 x 6m	£630.39	£407.99
EasyPond Auto 12000	12000	8000	£477.95	£359.99	5.0 / 16' 5"	4.0 / 13' 2"	0.6 / 2'	12000	2643	7 x 6m	£679.13	£431.99
EasyPond Auto 20000	20000	12000	£584.35	£449.99	5.4 / 17' 8"	3.6 / 11' 9"	1.0 / 3'	19440	4282	8 x 6m	£814.27	£539.99
EasyPond Auto 25000	30000	14000	£724.35	£589.99	5.0 / 16' 5"	5.0 / 16' 5"	1.0 / 3'	25000	5507	7.5 x 7.5m	£993.79	£707.99
EasyPond Auto 30000	40000	16000	£864.35	£729.99	6.5 / 21' 3"	4.5 / 14' 9"	1.0 / 3'	29250	6443	9 x 7m	£1166.12	£875.99
EasyPond Auto 50000	50000	16000	£1084.35	£939.99	9.0 / 20'	6.0 / 30'	1.0 / 3'	54000	11895	12 x 9m	£1709.87	£1199.99
EasyPond Auto 75000	75000	20000	£1264.55	£1109.99	10.0 / 33'	7.0 / 23'	1.0 / 3'	70000	15419	13 x 10m	£2017.25	£1449.99

Feature-Packed Pump & Filter Make pondkeeping a joy not a chore!

Further info on components can be found on the following pages:











- MightyMite Pump - Pg 48
- UltraFlow Pump - Pg 49
- SpinClean Auto Filter - pg 61
- Auto Pro - pg 63

Introducing EasyPond Auto Sets

Building on the EasyPond heritage - again a comprehensive range of Sizes to suit every garden. But now the feature count has been extended:

- PondXpert SpinClean Filters boast easyclean technology reducing maintenance.
- PondXpert UltraFlow Pumps boast class-leading performance (6000 set up)
- MightyMite Pumps sets mean easy-clean filtration sets now can be achieved in the smaller ponds at a low prices. (2000 / 3000 / 4500 sets).

Sets include 5m pond hose and 4 clamps. (25mm for smaller systems, 32mm for systems 20000-30000). Flexiliner 40yr and Pond Fleece Underlay included in complete kits.

					
EasyPond Auto 2000 7'6" x 4'3"	EasyPond Auto 3000 7'6" x 7'6"	EasyPond Auto 4500 10'6" x 7'6"	EasyPond Auto 6000 10'6" x 10'6"	EasyPond Auto 8000 13' x 10'	EasyPond Auto 12000 16' x 13'
					
EasyPond Auto 20000 17' 8" x 11' 9"	EasyPond Auto 25000 16' 5" x 16' 5"	EasyPond Auto 30000 21' 3" x 14' 9" 23' x 16' 5" if only 2' deep			

Filters with motorised cleaning



Smaller pond sizes (2000 to 12000 ltrs) based on a max depth of 0.6m (2') Larger set pond dimensions based on 1m depth (3'3")

Pond Building Guide - Preform Ponds



Filbert Frog's Top Tip

Pre-formed ponds must have good all-round support. Be sure to tamp and compress the sand or soil between the hole and sides of the pond.



1 Place the pond in position and carefully mark out its shape with stakes. Don't turn the pond upside down to mark out the shape, as this gives a mirror image of the pond and will not match up.

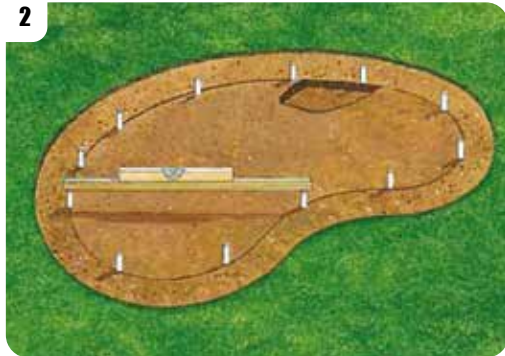

2 Position the pond right side up in the exact place you want it and use it as a guide or template while digging around the stakes. Make your outline 4-6 inches (10-15cm) larger than the pond itself. Verify the first level and start digging down to the shelves.



3 Reposition the pond, mark out the inner deeper section and continue digging out to the bottom. Be sure that the hole is slightly deeper than the actual depth of the preformed pond and verify that the pond is level. Remove any loose objects from the hole and add about 2" (5cm) of sand or fine soil to the base level and shelves.



4 Position the pre-formed pond into the excavation and verify it is level. Back-fill any spaces with sand or soil. Fill with water and leave to settle for at least a week before finishing off with your choice of edging.

Pond Tanks

Preformed Ponds - Buried Only

Preformed ponds are the easiest and quickest way to create a garden pond.

- Predetermined shape and depth
- No worries about creased material
- Ideal for poor soil conditions



PondXpert Preformed Ponds

A new range of durable ponds manufactured from high density polyethylene. Black colour finish and Lifetime Guarantee on all ponds. Models 2 and 3 have a smooth finish whereas the rest of the range are textured. (Note: dimensions include a 5cm Lip/overhang (11cm on 'Goldfish', 8cm on 'Koi').

**Textured ponds only*
Integral wildlife escape route and integral pump stand

Four great shapes to choose from:

- | | | | | |
|------------------|------------|-------------------------|---|--------------------|
| 1 *Minnow | RRP £59.99 | Our Price £29.99 | Dimensions: (LWH cm) 85 x 63 x 29 (2'9" x 2' x 1') | Volume: 55 Litres |
| 2 Guppy | RRP £69.99 | Our Price £34.99 | Dimensions: (LWH cm) 90 x 65 x 28 (3' x 2'2" x 1") | Volume: 70 Litres |
| 3 Rudd | RRP £79.99 | Our Price £39.99 | Dimensions: (LWH cm) 102 x 70 x 30 (3'3" x 2'3" x 1") | Volume: 100 Litres |
| 4 *Tench | RRP £99.99 | Our Price £49.99 | Dimensions: (LWH cm) 125 x 84 x 34 (4'1" x 2'9" x 1'1") | Volume: 120 Litres |

The following larger ponds are great value considering they have a 2 man delivery.

- | | | | | |
|--------------------|-------------|--------------------------|---|--------------------|
| 5 *Goldfish | RRP £259.99 | Our Price £129.99 | Dimensions: (LWH cm) 150 x 110 x 34 (4'11" x 3'7" x 1'1") | Volume: 172 Litres |
| 6 *Koi | RRP £299.99 | Our Price £149.99 | Dimensions: (LWH cm) 164 x 122 x 42 (5'4" x 4' x 1'4") | Volume: 460 Litres |



- Special Offer -

Half Price All-in-One Pond Pump with any preformed pond purchase. -----
PondXpert TripleAction 2000 All-in-One Pump (see page 31).

Usually £79.99 **Only £39.99**



Raised Ponds



Instalog 175 Gallon Shown

Instalog Wooden Ponds

These pools are all based on an extremely easy to assemble system of interlocking "logs" which slot together and build up in layers thus doing away with the need for specialist fixings.

They are all simple to assemble and disassemble, so you can move them to another part of the garden or patio.

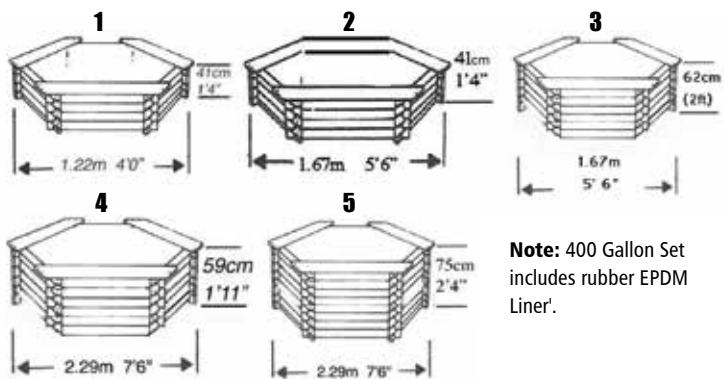

Note: 400 Gallon Set includes rubber EPDM Liner.

- 1 50 Gallon (227 litres)**
RRP £255.49 **Our Price £214.99**
- 2 100 Gallon (454 litres)**
RRP £353.49 **Our Price £299.99**
- 3 175 Gallon (795 litres)**
RRP £454.95 **Our Price £419.99**
- 4 300 Gallon (1362 litres)**
RRP £640.52 **Our Price £499.99**
- 5 400 Gallon (1816 litres)**
RRP £1067.58 **Our Price £839.99**



Half Price

All-in-One Pump Offer

Buy any Intalog Pond and claim PondXpert TripleAction Pump for **£39.99** (usually £79.99) (see page 31)

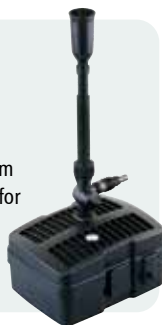

PondXpert Round Pond 1000 Ltr

Extra-large round plastic pond that can be used self-standing or partially buried.

Dimensions: Diameter 1.4m (4' 7")
Height 0.9m (3')
Vol. 1000 Ltrs (220 Galls)

Manufactured out of heavy duty plastic this pond features an elegant 'rolled' top and it's shape tapers down attractively to 1.17m (3' 10").

RRP £799.99
Our Price £399.99

Price includes pallet delivery to mainland UK.



Pond shown against an adult bicycle to help illustrate scale

Pond Tanks



More Round Tub Sizes Available Online!

PondXpert Round Tub 90 Ltr

Round plastic pond or reservoir that can be self-standing or buried.

Dimensions:
Diameter 67cm (2' 3")
Height 35m (1' 2")
Vol. 90 Ltrs (20 Galls)

RRP £49.99
Our Price £24.99



PondXpert Round Tub 150 Ltr

Dimensions:
Diameter 88cm
Height 32m
Vol. 150 Ltrs

RRP £129.99
Our Price £64.99



PondXpert HD Lid 85cm

(fits 150 Ltr Tub)
This heavy duty lid is perfect size for most wooden half-barrels.

RRP £159.99
Our Price £79.99

150 Ltr Tub + Lid Set

Usual Price £144.98
Our Price £119.99



PondXpert Round Tub 90 Ltr Lid

Heavy-duty lid for use with 90 Ltr tub.
Diameter 67cm (2' 3").

RRP £79.99
Our Price £39.99



PondXpert Round Tub 90 Ltr & Lid Set DEAL

Our Price £54.99
Save £9.99

Super Value (lightweight) Sump+ Lid Kit
Add a Pebble Pond Kit (pg 16) to a 90 Ltr Tub
90 Ltr + Standard round PPK £39.99 (save £5)
90 Ltr + Heavy Duty PPK £54.99 (save £10)

Pump sits inside pebble pond 'bowl' suspended above the round 90ltr tank (need to perforate bowl).

Easier to reach pump without getting sleeves wet
Bigger reservoir means less 'topping up' of water

PondXpert Round Tub 275 Ltr

Dimensions:
Dia. 1.12m (3' 8")
Height 0.33m (1' 1")
Vol 275 ltrs (61 gallons)

RRP £259.99
Our Price £129.99



Pond Tanks

Small Tank

105 x 72 x 30cm 3' 6" x 2' x 1"
Pond Volume 227 litres, (50 gall).

Our Price £99.99



Medium Tank

130 x 80 x 46cm 4' 3" x 2' 7" x 1' 6"
Pond Volume 410 litres, (90 gall).

Our Price £199.99



Laguna tanks are super-strong and can be positioned above ground if required.

Opportunity exists to wrap a non-load bearing frame around pond as shown below.



Laguna Large Tank (1000L) with decorative frame created by interlocking railway sleepers.

Note: Laguna Wood Frames discontinued.

Large Tank

180 x 120 x 60cm (6' x 4' x 2')
Pond Volume 1000 Litres.

Our Price £449.99



Bestseller

Biggest tank we have found that can stand unsupported when full of water.

(Similar sized round tank pg 13)

Price includes pallet delivery to mainland UK

Blagdon Liberty No Dig Nature Pool

Complete pond kit that allows you to create a 'pop up' thriving ecosystem in your own garden.

Kit includes everything you need to get started, including a solar floating fountain pump, wood-effect resin panels, fibre reinforced liner and underlay, beach with planting pocket and wildlife ladder.

- Easy to build - Click fit in under an hour
- Includes bird bathing beach & wildlife Ladder
- 3 year guarantee
- Includes Blagdon Liberty Solar Pump with 180lph flow rate.

Dimensions: 95 x 95 x 36cm (LWH)
Capacity: 190 Litres (42 Gallons)

RRP £224.99

Our Price £199.99



Full range of Blagdon Affinity Ponds available online!

Raised Ponds

Transform your garden in 30 minutes



* Artist's illustration

Hozelock Outdoor Aquarium

Simple & easy installation within 30 minutes by one person. Simple 'Twist & Lock' system means no tools are required.

95 x 95 x 70cm LWH (3'1" x 3'1" x 2'4")

25% larger capacity compared to medium sized Blagdon Affinity ponds.

3 Year Guarantee.

- Contemporary raised pond design.
- Ideal for smaller gardens.
- No Digging.
- Safe for small children.
- Our exclusive special offer sets provide a complete pond set-up at a great low price.

RRP £434.99 Was £329.99

Sale Price £299.99



- Special Offer -

Hozelock Outdoor Aquarium + PondXpert TripleAction 2000
£339.99 Save £39.99

Pebble Pond Kits

PondXpert Pebble Pond Kits

Include reservoir and lid.



1 Standard Round £19.99

66cm diameter x 20cm depth Max volume: 16 Litres. max Load 25kg
Note: One typical bag of white cobbles weights 25kg

2 Heavy Duty Round £39.99

Delisted by supplier - new version being sourced
65cm diameter x 28cm depth Max volume: 16 Litres. max Load 50kg

3 Standard Square £69.99

Delisted by supplier - new version being sourced
80cm diameter x 30cm depth Max volume: 30 Litres. max Load 25kg



Solar Pebble Pond Kits

Just add pebbles and water! (not included)

Solar Pebble Kit 250 - Direct Only

Kit includes the following items:

- PondXpert Standard Round Kit
- PondXpert SunnyPump 250 (see pg 37)

Our Price £39.99 you save **£9.99***

Solar Pebble Kit 200 - Battery

Kit includes the following items:

- PondXpert Standard Round Kit
- PondXpert SolarShower 200 Pump (see pg 41)

Our Price £69.99 you save **£9.99***

* Saving compared to buying items separately



Pebble Ponds *Luxury DIY Pebble Kit*



Round Feature Basin

66cm x 31cm (22") diameter tank holds 68 litres of water.

RRP £22.89 **Our Price £19.99**



Heavy Duty Lid

66cm (22") diameter grill fits securely onto the top of the Round Basin via fixing stumps.

RRP £79.99 **Our Price £39.99**



Round Basin & Lid Deal

Create a self-contained water feature with this heavy duty grid & 68ltr reservoir.

Combo Deal Price £59.98 £49.99

Save **£9.99***

*on buying individually

Pond Fun Features

PondXpert ViewTube Fish Towers

Watch in wonder as your fish magically appear and swim above your pond surface.

Made out of clear acrylic the Tower stands 65cm high (40cm tube + 30cm stand) with a diameter of 20cm

Fish will be attracted by warmer water inside tube or food can be added as an incentive.

Designed for small/medium fish. Not suitable for mature koi.

RRP £139.99 Was £69.99 **Sale Price £49.99**

Installation Notes

Metal stand must be placed on a stable flat surface. You will need to get into your pond and completely submerge the tower underwater before using a 'tilt and lift' motion to position it on its stand with base of tower still under the water.

Alternatively if you have a pond vacuum this can be used to suck the air out of the dome and it will automatically fill with water.



PondXpert ViewTube Large

Wider tower allows big fish to enjoy the view!

50% larger diameter column (30cm vs 20cm).

RRP £199.99 Was £99.99 **Sale Price £79.99**



Koi Domes

Velda Dome

35cm Dia

Our Price £79.99



NEW

PondXpert Dome

30cm Dia

Our Price £49.99



PondKeeper Pond Liner Build Project

We built our pond using an EasyPond 30,000 Complete Kit. We then finished the pond with PondXpert Stone Liner and underwater lights.



1 For a big pond like ours we recommend hiring a mini excavator. Hire by the day or weekend - great fun!



2 Finishing the dig by hand - digging out shelves and smoothing the surface. Get rid of as many stones as you can.



3 Due to the very stony nature of the ground we chose to upgrade to Fleece Underlay (Dog optional!)



4 Once the liner has been unfolded it's time to smooth it into the shelves and corners as best you can (barefoot is best).



5 Fill pond with water. We filled ours straight from the mains via a hosepipe.



6 Weigh liner edges down then smooth away folds as water starts to fill the pond.

Pond Liners

All ponds start by digging a hole in the earth and then lining it before filling with water. A liner is essential as it creates a watertight barrier to stop the water seeping back into the earth.

We are a pond liner specialist and we want to guide you into making the correct choice.

Our 'ready reckoner' in the first column of our liner listings (22-23) shows the resulting pond that can be created by the many pre-cut sizes we have in stock.

With flexible liners the choice of pond shape and depth are up to you. If keeping fish we recommend at least part of the pond to be 1m deep for fish to overwinter.

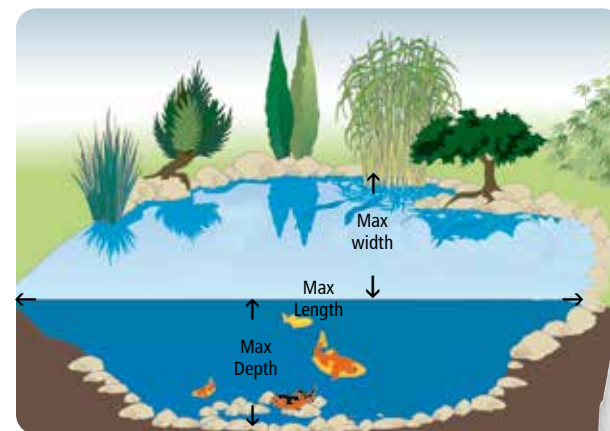

Calculating your liner size

Length =
max. pond length + (depth x 2) + 1m overlap

Width =
max. pond width + (depth x 2) + 1m overlap

PondXpert EPDM Bonding Mastic 310ml

Use to bond rubber liners.

Our Price £14.99
Cartridge Gun £7.99
Mastic + Gun Set £19.99

Pond Liner Materials Stocked (Pre-cut next day service)

LDPE (Low Density Polyethylene)

Best for value. Hardwearing and tough yet light in weight

From ~~£1.99~~ £3.99/sqm

PVC (Polyvinyl chloride)

Heavier weight & increased elasticity

Check out **NEW 'Seamless' version** on widths up to 3m!

From ~~£4.49~~ £3.29/sqm

Rubber

Premium solution. Maximum thickness and ultimate flexibility. Three types: Butyl, EPDM and Firestone

From ~~£9.49~~ £9.99/sqm

Did you know? Pondkeeper is a pond liner market specialist. Over the last 21 years we have supplied liner for over **one million** pond builds - mostly here in the UK. That's a LOT of happy frogs!



Concrete Pond Accessories

G4 Clear

	RRP	Our Price
1Kg	£32.59	£29.99
2.5Kg	£64.59	£59.99
5Kg	£102.99	£99.99
25Kg	£427.99	£399.99

G4 Black

1Kg	£44.99	£39.99
2.5Kg	£95.49	£89.99
5Kg	£172.89	£169.99
25Kg	£718.99	£699.99



Bonda V11 Glass Fibre Filler - 1kg

Holds rocks together and directs water where you want it to go!

- Rapid hardening
- Includes hardener & plastic spreader.

RRP £51.99 **Our Price £27.99**

Just Fix It

Two part putty repairs cracks & holes in concrete.

RRP £8.25 **Our Price £7.99** Product delisted - alternative being sourced



PondXpert PVC Pond Liner

Liner offered in two thicknesses

0.3mm 20r guarantee

0.5mm 30yr guarantee

0.3mm was £4.49 now **£3.29 /sqm**

0.5mm was £4.89 now **£3.99 /sqm**

High-quality, single-ply black PVC pond liner, fully guaranteed. Designed for durability, it is UV-resistant, rot-resistant, and fish-safe.



PVC is highly flexible liner material making it easy to install & shape into complex positions.



0.3mm Size	Was	SALE PRICE		0.5mm Size	Was	SALE PRICE	
2x1.5m	£13.47	£9.87	Seamless	2x1.5m	£14.67	£11.97	Seamless
2x2m	£17.96	£13.16	Seamless	2x2m	£19.56	£15.96	Seamless
2.5x2.5m	£28.06	£20.56	Seamless	2.5x2.5m	£30.56	£24.94	Seamless
3x2m	£26.94	£19.74	Seamless	3x2m	£29.34	£23.94	Seamless
3x3m	£40.41	£29.61	Seamless	3x3m	£44.01	£35.91	Seamless
4x3m	£53.88	£39.48	Seamless	4x3m	£58.68	£47.88	Seamless
4x4m	£71.84	£52.64	Seamless	4x4m	£78.24	£63.84	Seamless
5x3m	£67.35	£49.35	Seamless	5x3m	£73.35	£59.85	Seamless
5x4m	£89.80	£65.80	Seamless	5x4m	£97.80	£79.80	Seamless
5x5m	£112.25	£82.25	Seamless	5x5m	£122.25	£99.75	Seamless
6x3m	£80.82	£59.22	Seamless	6x3m	£88.02	£71.82	Seamless
6x4m	£107.76	£78.96	Seamless	6x4m	£117.36	£95.76	Seamless
6x5m	£134.70	£98.70	Seamless	6x5m	£146.70	£119.70	Seamless
6x6m	£161.64	£118.44	Seamless	6x6m	£176.04	£143.64	Seamless
7x5m	£157.15	£115.15	Seamless	7x5m	£171.15	£139.65	Seamless
7x6m	£188.58	£138.18	Seamless	7x6m	£205.38	£167.58	Seamless
8x6m	£215.52	£157.92	Seamless	8x6m	£234.72	£191.52	Seamless
8x8m	£287.36	£210.56	Seamless	8x8m	£312.96	£255.36	Seamless
9x7m	£282.87	£207.27	Seamless	9x7m	£308.07	£251.37	Seamless
10x6m	£269.40	£197.40	Seamless	10x6m	£293.40	£239.40	Seamless
10x8m	£359.20	£263.20	Seamless	10x8m	£391.20	£319.20	Seamless

Seamless option: Single pieces of PVC without joins. Available on all sizes up to 3m width

NEW

Half Price Underlay with 30yr PVC

Firestone Rubber 1.02mm Was £12.85 Now **£11.49** per sqm (£1.07 sq ft).

This EPDM geomembrane is the thickest liner we sell (1mm).

It is straightforward to seam or repair and is guaranteed for 20 years. Uniquely this liner sizes is measured off in imperial measurements (feet).

Note: Firestone has been re-named by new brand owners. If FS brand stock not available liner will be substituted with similar quality 1mm thickness EPDM liner.



L x W Metres	Was	SALE PRICE
3.1 x 2.4	£95.63	£85.51
3.1 x 3.1	£119.54	£106.89
3.7 x 3.1	£143.44	£128.26
4.0 x 3.1	£155.20	£138.78
4.9 x 4.3	£267.76	£239.42
5.5 x 4.3	£301.23	£269.35
6.1 x 4.9	£382.52	£342.03
6.1 x 5.5	£430.33	£384.79
6.7 x 6.1	£525.96	£470.30
7.9 x 6.1	£620.81	£555.10
9.1 x 7.9	£930.20	£831.75
12.2 x 8.5	£1,336.15	£1,194.74
12.2 x 9.2	£1,433.27	£1,281.58
30.5 x 15.2	£5,969.02	£5,337.28

Over 60 more sizes exist online - We can supply any of the listed widths in maximum lengths of 100' (30.5m)

Pond Liners



Liners pre-cut & ready to go!

All successful pond projects start with a good waterproof pond liner. A pond liner provides a watertight membrane to stop pond water seeping away.

PVC Pond Liner

We have extended our range of 0.5mm and 0.3mm PVC liners this year. Thicker than LDPE but not tearproof. These are priced:

20yr guarantee **0.3mm £3.29/sqm** was £4.49 (£0.31 sq ft)
30yr guarantee **0.5mm £3.99/sqm** was £4.89 (£0.37 sq ft)



BIG offer Details opposite! Check out new 'seamless' option.

Butyl rubber

First choice for professionals for many years. Lifetime guarantee (20yrs on 0.75mm thick).

£12.49 **£11.49** per sqm (£1.07 sq ft)

EPDM rubber

Same physical characteristics as Butyl but with significant cost savings. Lifetime guarantee (20yrs on 140sqm plus), 0.75mm thick. We find that this synthetic rubber now outsells butyl.

Only **£9.49** per sqm (£0.88 sq ft)

Flexiliner LDPE

Our bestselling liner. Double-laminated with a reinforced core. Durable, tearproof yet light to work with. The perfect Garden pond liner.

Half-Price Underlay Offer Over 100 pre-cut sizes - See overleaf

From only **£1.99** per sqm (£0.18 sq ft)



Half Price Fleece Underlay on 30yr guarantee only



Half Price Fleece Underlay



Half Price Fleece Underlay



Half Price Fleece Underlay OR Half Price Basic Underlay

Underlay

We recommend that all pond liners are underlaid as extra protection for your liner. It helps to prevent root penetration and punctures from small stones/debris. Underlay supplied matches the sqm of our liners.

"Basic" is a budget underlay, providing a good level of protection. Particularly suitable for small ponds or where sand is used as a primary barrier.

Only **£1.80** per sqm (£0.17 sq foot)

"Pond Fleece" premium underlay is a heavy 200gsm needled felt. Recommended for all ponds - particularly larger liners or stoney ground.

Only **£2.80** per sqm (£0.26 sq foot)

Glue & Repair Tape/Kits

Heissner easyFIX Tape Waterproof tape. Available in black or clear colour. 10cm wide x 150cm length.

easyFIX Black Our Price £19.99
easyFIX Clear Our Price £19.99

Cold Glue double-sided tape can be used on all liners* - use it to join liners together or to fix punctures or tears. 5cm wide (2inch) 2mm thick.

£5.00 per linear mtr.
£34.99 for 10m roll

Velda VT PVC Patch Kit High performance underwater adhesive with PVC liner piece (40x20cm). Works with all PVC liners.

RRP £17.99 **£14.49**

PondXpert Pond Liner Repair Kits

A4 sized Flexiliner & 1m Cold Glue	£5.99
A4 sized EPDM Liner & 1m Cold Glue	£8.99
A4 Sized Butyl Liner & 1m Cold Glue	£9.99
50x50cm Flexiliner & 3m Cold Glue	£19.99
50x50cm EPDM & 3m Cold Glue	£24.99
50x50cm Butyl & 3m Cold Glue	£29.99
1x1m Flexiliner & 10m Cold Glue	£39.99
1x1m EPDM Liner & 10m Cold Glue	£49.99
1x1m Butyl Liner & 10m Cold Glue	£59.99

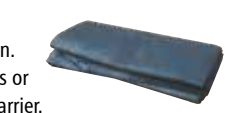

Max Pond Size (LxWxD)	Liner Size Metres	Flexiliner - LDPE			PVC	Rubber Liners		Underlay Choice		BEST DEAL ½ PRICE FLEECE + 40Yr LINER
		15yr	25yr	40yr	0.3mm	EPDM	Butyl	Fleece	Basic	
0.4x0.4x0.3	2 x 2	£7.96	£9.96	£11.96	£13.16*	£37.96	£45.96	£11.20	£7.20	£17.56
0.9x0.4x0.3	2.5 x 2	£9.95	£12.45	£14.95	-	£47.45	£57.45	£14.00	£9.00	£21.95
0.9x0.9x0.3	2.5 x 2.5	£12.44	£15.56	£18.69	£20.56*	£59.31	£71.81	£17.50	£11.25	£27.44
1.4x0.4x0.3	3 x 2	£11.94	£14.94	£17.94	£19.74*	£56.94	£68.94	£16.80	£10.80	£26.34
1.4x0.9x0.3	3 x 2.5	£14.93	£18.68	£22.43	-	£71.18	£86.18	£21.00	£13.50	£32.93
1 x 1 x 0.5	3 x 3	£17.91	£22.41	£26.91	£29.61*	£85.41	£103.41	£25.20	£16.20	£39.51
1.5 x 1 x 0.5	3.5 x 3	£20.90	£26.15	£31.40	-	£99.64	£120.65	£29.40	£18.90	£46.10
2 x 1 x 0.5	4 x 3	£23.88	£29.88	£35.88	£39.48*	£113.88	£137.88	£33.60	£21.60	£52.68
2 x 1.5 x 0.5	4 x 3.5	£27.86	£34.86	£41.86	-	£132.86	£160.86	£39.20	£25.20	£61.46
2 x 2 x 0.5	4 x 4	£31.84	£39.84	£47.84	£52.64	£151.84	£183.84	£44.80	£28.80	£70.24
2.5 x 2 x 0.5	4.5 x 4	£35.82	£44.82	£53.82	-	£170.82	£206.82	£50.40	£32.40	£79.02
3 x 1 x 0.5	5 x 3	£29.85	£37.35	£44.85	£49.35*	£142.35	£172.35	£42.00	£27.00	£65.85
2 x 1 x 1	5 x 4	£39.80	£49.80	£59.80	£65.80	£189.80	£229.80	£56.00	£36.00	£87.80
2 x 1.5 x 1	5 x 4.5	£44.78	£56.03	£67.28	-	£213.15	£258.53	£63.00	£40.50	£98.78
2 x 2 x 1	5 x 5	£49.75	£62.25	£74.75	£82.25	£237.25	£287.25	£70.00	£45.00	£109.75
2 x 2.5 x 1	5.5 x 5	£54.73	£68.48	£82.23	-	£260.98	£315.98	£77.00	£49.50	£120.73
4 x 1 x 0.5	6 x 3	£35.82	£44.82	£53.82	£59.22*	£170.82	£206.82	£50.40	£32.40	£79.02
3 x 1 x 1	6 x 4	£47.76	£59.76	£71.76	£78.96	£227.76	£275.76	£67.20	£43.20	£105.36
3 x 1.5 x 1	6 x 4.5	£53.73	£67.23	£80.73	-	£256.23	£310.23	£75.60	£48.60	£118.53
3 x 2 x 1	6 x 5	£59.70	£74.70	£89.70	£98.70	£284.70	£344.70	£84.00	£54.00	£131.70
3 x 2.5 x 1	6 x 5.5	£65.67	£82.17	£98.67	-	£313.17	£379.17	£92.40	£59.40	£144.87
3 x 3 x 1	6 x 6	£71.64	£89.64	£107.64	£118.44	£341.64	£413.64	£100.80	£64.80	£158.04
3 x 3.5 x 1	6.5 x 6	£77.61	£97.11	£116.61	-	£370.11	£448.11	£109.20	£70.20	£171.21
5 x 1 x 0.5	7 x 3	£41.79	£52.29	£62.79	-	£199.29	£241.29	£58.80	£37.80	£92.19
4 x 1 x 1	7 x 4	£55.72	£69.72	£83.72	-	£265.72	£321.72	£78.40	£50.40	£122.92
4 x 2 x 1	7 x 5	£69.65	£87.15	£104.65	£115.15	£332.15	£402.15	£98.00	£63.00	£153.65
4 x 2.5 x 1	7 x 5.5	£76.62	£95.87	£115.12	-	£365.37	£442.37	£107.80	£69.30	£169.02
4 x 3 x 1	7 x 6	£83.58	£104.58	£125.58	£138.18	£398.58	£482.58	£117.60	£75.60	£184.38
4 x 3.5 x 1	7 x 6.5	£90.55	£113.30	£136.05	-	£431.80	£522.80	£127.40	£81.90	£199.75
4 x 4 x 1	7 x 7	£97.51	£122.01	£146.51	-	£465.01	£563.01	£137.20	£88.20	£215.11
4.5 x 3 x 1	7.5 x 6	£89.55	£112.05	£134.55	-	£427.05	£517.05	£126.00	£81.00	£197.55
4.5 x 4 x 1	7.5 x 7	£104.48	£130.73	£156.98	-	£498.23	£603.23	£147.00	£94.50	£230.48
4.5 x 4.5 x 1	7.5 x 7.5	£111.94	£140.06	£168.19	-	£533.81	£646.31	£157.50	£101.25	£246.94
6 x 1 x 0.5	8 x 3	£47.76	£59.76	£71.76	-	£227.76	£275.76	£67.20	£43.20	£105.36
5 x 1 x 1	8 x 4	£63.68	£79.68	£95.68	-	£303.68	£367.68	£89.60	£57.60	£140.48
5 x 2 x 1	8 x 5	£79.60	£99.60	£119.60	-	£379.60	£459.60	£112.00	£72.00	£175.60
5 x 3 x 1	8 x 6	£95.52	£119.52	£143.52	£157.92	£455.52	£551.52	£134.40	£86.40	£210.72
5 x 4 x 1	8 x 7	£111.44	£139.44	£167.44	-	£531.44	£643.44	£156.80	£100.80	£245.84
5 x 5 x 1	8 x 8	£127.36	£159.36	£191.36	£210.56	£607.36	£735.36	£179.20	£115.20	£280.96
6 x 2 x 1	9 x 5	£89.55	£112.05	£134.55	-	£427.05	£517.05	£126.00	£81.00	£197.55
6 x 3 x 1	9 x 6	£107.46	£134.46	£161.46	-	£512.46	£620.46	£151.20	£97.20	£237.06
6 x 4 x 1	9 x 7	£125.37	£156.87	£188.37	£207.27	£597.87	£723.87	£176.40	£113.40	£276.57
6 x 5 x 1	9 x 8	£143.28	£179.28	£215.28	-	£683.28	£827.28	£201.60	£129.60	£316.08
6 x 6 x 1	9 x 9	£161.19	£201.69	£242.19	-	£768.69	£930.69	£226.80	£145.80	£355.59
7 x 2 x 1	10 x 5	£99.50	£124.50	£149.50	£197.40	£474.50	£574.50	£140.00	£90.00	£219.50
7 x 3 x 1	10 x 6	£119.40	£149.40	£179.40	-	£569.40	£689.40	£168.00	£108.00	£263.40
7 x 4 x 1	10 x 7	£139.30	£174.30	£209.30	-	£644.30	£804.30	£196.00	£126.00	£307.30
7 x 5 x 1	10 x 8	£159.20	£199.20	£239.20	£263.20	£759.20	£919.20	£224.00	£144.00	£351.20
7 x 6 x 1	10 x 9	£179.10	£224.10	£269.10	-	£854.10	£1,034.10	£252.00	£162.00	£395.10

Max Pond Size (LxWxD)	Liner Size Metres	Flexiliner - LDPE			PVC	Rubber Liners		Underlay Choice		BEST DEAL ½ PRICE FLEECE + 40Yr LINER
		15yr	25yr	40yr	Special Order PVC 0.5mm	EPDM	Butyl	Fleece	Basic	
7 x 7 x 1	10 x 10	£199.00	£249.00	£299.00		£949.00	£1,149.00	£280.00	£180.00	£439.00
8 x 4 x 1	11 x 7	£153.23	£191.73	£230.23		£730.73	£884.73	£215.60	£138.60	£338.03
8 x 5 x 1	11 x 8	£175.12	£219.12	£263.12		£835.12	£1,011.12	£246.40	£158.40	£386.32
8 x 6 x 1	11 x 9	£197.01	£246.51	£296.01		£939.51	£1,137.51	£277.20	£178.20	£434.61
8 x 7 x 1	11 x 10	£218.90	£273.90	£328.90		£1,043.90	£1,263.90	£308.00	£198.00	£482.90
9 x 4 x 1	12 x 7	£167.16	£209.16	£251.16		£797.16	£965.16	£235.20	£151.20	£368.76
9 x 5 x 1	12 x 8	£191.04	£239.04	£287.04		£911.04	£1,103.04	£268.80	£172.80	£421.44
9 x 6 x 1	12 x 9	£214.92	£268.92	£322.92		£1,024.92	£1,240.92	£302.40	£194.40	£474.12
9 x 7 x 1	12 x 10	£238.80	£298.80	£358.80		£1,138.80	£1,378.80	£336.00	£216.00	£526.80
9 x 9 x 1	12 x 12	£286.56	£358.56	£430.56		£1,366.56	£1,654.56	£403.20	£259.20	£632.16
10 x 5 x 1	13 x 8	£206.96	£258.96	£310.96		£986.96	£1,194.96	£291.20	£187.20	£456.56
10 x 6 x 1	13 x 9	£232.83	£291.33	£349.83		£1,110.33	£1,344.33	£327.60	£210.60	£513.63
10 x 7 x 1	13 x 10	£258.70	£323.70	£388.70		£1,233.70	£1,493.70	£364.00	£234.00	£570.70
10 x 9 x 1	13 x 12	£310.44	£388.44	£466.44		£1,480.44	£1,792.44	£436.80	£280.80	£684.84
10 x 10 x 1	13 x 13	£336.31	£420.81	£505.31		£1,603.81	£1,941.81	£473.20	£304.20	£741.91
11 x 5 x 1	14 x 8	£222.88	£278.88	£334.88		£1,062.88	£1,286.88	£313.60	£201.60	£491.68
11 x 6 x 1	14 x 9	£250.74	£313.74	£376.74		£1,195.74	£1,447.74	£352.80	£226.80	£553.14
11 x 7 x 1	14 x 10	£278.60	£348.60	£418.60		£1,328.60	£1,608.60	£392.00	£252.00	£614.60
11 x 9 x 1	14 x 12	£334.32	£418.32	£502.32		£1,594.32	£1,930.32	£470.40	£302.40	£737.52
11 x 11 x 1	14 x 14	£390.04	£488.04	£586.04		£1,860.04	£2,252.04	£548.80	£352.80	£860.44
12 x 5 x 1	15 x 8	£238.80	£298.80	£358.80		£1,138.80	£1,378.80	£336.00	£216.00	£526.80
12 x 6 x 1	15 x 9	£268.65	£336.15	£403.65		£1,287.15	£1,551.15	£378.00	£243.00	£592.65
12 x 7 x 1	15 x 10	£298.50	£373.50	£448.50		£1,423.50	£1,723.50	£420.00	£270.00	£658.50
12 x 9 x 1	15 x 12	£358.20	£448.20	£538.20		£1,708.20	£2,068.20	£504.00	£324.00	£790.20
12 x 12 x 1	15 x 15	£447.75	£560.25	£672.75		£2,135.25	£2,585.25	£630.00	£405.00	£987.75
13 x 7 x 1	16 x 10	£318.40	£398.40	£478.40		£1,518.40	£1,838.40	£448.00	£288.00	£702.40
13 x 9 x 1	16 x 12	£382.08	£478.08	£574.08		£1,822.08	£2,206.08	£537.60	£345.60	£842.88
15 x 7 x 1	18 x 10	£358.20	£448.20	£538.20		£1,708.20	£2,068.20	£504.00	£324.00	£790.20
15 x 9 x 1	18 x 12	£429.84	£537.84	£645.84		£2,049.84	£2,481.84	£604.80	£388.80	£948.24
15 x 12 x 1	18 x 15	£537.30	£672.30	£807.30		£2,562.30	£3,102.30	£756.00	£486.00	£1,185.30
17 x 12 x 1	20 x 15	£597.00	£747.00	£897.00		£2,847.00	£3,447.00	£840.00	£540.00	£1,317.00
17 x 15 x 1	20 x 18	£716.40	£896.40	£1,076.40		£3,416.40	£4,136.40	£1,008.00	£648.00	£1,580.40
21 x 12 x 1	24 x 15	£716.40	£896.40	£1,076.40		£3,416.40	£4,136.40	£1,008.00	£648.00	£1,580.40
21 x 15 x 1	24 x 18	£859.68	£1,075.68	£1,291.68		£4,099.68	£4,963.68	£1,209.60	£777.60	£1,896.48
23 x 15 x 1	26 x 18	£931.32	£1,165.32	£1,399.32		£4,441.32	£5,377.32	£1,310.40	£842.40	£2,054.52
23 x 17 x 1	26 x 20	£1,034.80	£1,294.80	£1,554.80		£4,934.80	£5,974.80	£1,456.00	£936.00	£2,282.80
25 x 15 x 1	28 x 18	£1,002.96	£1,254.96	£1,506.96		£4,782.96	£5,790.96	£1,411.20	£907.20	£2,212.56
25 x 17 x 1	28 x 20	£1,114.40	£1,394.40	£1,674.40		£5,314.40	£6,434.40	£1,568.00	£1,008.00	£2,458.40
27 x 13 x 1	30 x 16	£955.20	£1,195.20	£1,435.20		£4,555.20	£5,515.20	£1,344.00	£864.00	£2,107.20
27 x 15 x 1	30 x 18	£1,074.60	£1,344.60	£1,614.60		£5,124.60	£6,204.60	£1,512.00	£972.00	£2,370.60
27 x 17 x 1	30 x 20	£1,194.00	£1,494.00	£1,794.00		£5,694.00	£6,894.00	£1,680.00	£1,080.00	£2,634.00
29 x 17 x 1	32 x 20	£1,273.60	£1,593.60	£1,913.60		£6,073.60	£7,353.			

Pond Liner Edging

Spring Sale



Bestseller



"Classic" Finish



10% Bulk discount on full rolls

Price per linear metre, cut off roll	Was	NOW	Full Roll	
			Length	PRICE
Stone Liner 0.4m Classic	£11.99	£9.49	25m	£212.99
Stone Liner 0.6m Classic	£16.99	£14.99	20m	£268.99
Stone Liner 1.0m Classic	£29.99	£24.99	12m	£268.99
Stone Liner 1.2m Classic	£39.99	£31.99	12m	£349.99

"Pebble" or "Stone-Faced" liner protects the exposed parts of the pond liner and makes the transition between pond and land seamless.

This special material is manufactured in the Netherlands and our unique direct relationship with the producer means we can sell it to you at an exclusive price.

With approximately 225 stone particles per square inch this is the best quality stone liner around.

You can find the same product under other brand names elsewhere at a much higher price. *Grab yourself a bargain!*



Filbert Frog's Top Tip

This stone liner can be used to create a beach area which is perfect for me and my pondlife buddies. It lets us get in and out of the water as we please.

Also obstructions such as pond hose and electrical cable can be hidden underneath the additional layer of cover - this makes our pool look a whole lot better!



A mix of grey granite colour & lighter stones

TerraZZo Finish



10% Bulk discount on full rolls

Price per linear metre, cut off roll	Was	NOW	Full Roll	
			Length	PRICE
Stone Liner 0.4m TerraZZo	£11.99	£10.99	25m	£244.99
Stone Liner 0.6m TerraZZo	£16.99	£16.49	20m	£304.99
Stone Liner 1.0m TerraZZo	£29.99	£26.99	12m	£289.99
Stone Liner 1.2m TerraZZo	£39.99	£34.99	12m	£374.99

Water Courses

NEW

PondXpert Cascades

Realistic sandstone watercourse elements perfect for creating a pond waterfall.

- Quick installation.
- Use individually or combined to make a longer waterfall.
- Optional 12mm hidden water inlet



Cascade Header

Flat stone usually placed at the top of a waterfall - also looks good as a whole fall.

RRP £199.99

Our Price **£99.99**

63 x 61 x 15 cm (LWH)



Cascade Stream

Stream fall - looks great alone or as part of a set.

RRP £279.99

Our Price **£139.99**

95 x 47 x 14 cm (LWH)



Cascade Base

Wider stream.

RRP £219.99

Our Price **£109.99**

61 x 41 x 13 cm (LWH)



Display suggestion

NEW

PondXpert Solar Cascades

Same realistic sandstone watercourse elements but supplied with integrated solar lighting. An exciting new approach to water garden landscaping.



Cascade Solar Header

RRP £229.99

Our Price **£114.99**



Cascade Solar Base

RRP £249.99

Our Price **£124.99**



Cascade Solar Stream

RRP £319.99

Our Price **£159.99**

COMBINATION DEAL

Buy all three PondXpert Cascades

Separates price £349.97

Deal Price **£299.99**



Save £49.98

Solar Falls Combination Deal

Separates price £399.97

Deal Price **£349.99**



Solar Cascade options available with white or colour LEDs.

Water Courses

Our new 'Riverstone' falls have been created to add an instant authentic appeal to your pond. Use individually or join together to create a longer waterfall. Recommended pump flow 1500LPHs.

River Slate range come in a beautiful 'aged' appearance - grey with a touch of algae green for an ultra realistic effect.

River Slate Cascade 67x 57 x 16cm (LWH)
RRP £137.99
Our Price £109.99



River Slate Drop
64 x 62 x 20cm (LWH)
RRP £137.99
Our Price £109.99



River Pebbles give the effect of white boulder streams.



River Pebbles Stream
70 x 54 x 20cm (LWH)
RRP £137.99
Our Price £109.99



River Pebbles Drop
69 x 61 x 20cm (LWH)
RRP £137.99
Our Price £109.99



Slate Fast Falls

Narrow channel creates a fast flowing rapid. Rec. Flow 2000lph. Dimensions: 104 x 70 x 29 cm (LWH). Available in Rustic Slate or Grey Slate finish.

RRP £280.99
Our Price £229.99



Water Courses

Most ponds have a waterfall. They create a real focal point and the bubbling water helps to oxygenate the pond. Also you will find a natural bank of earth is created by the displaced soil after your pond dig. The following pages show the best preformed watercourses on the market today.

Sandstone Series

are made out of tough fibreglass but the surfaces are hand finished to resemble real stone. These falls can be used individually or joined together to create a longer stream. (Dimensions cm W x L x Pour)



Curved Stream
70x107x30cm
RRP £264.99
Our Price £219.99



Tiered Cascade
55x71x38cm
RRP £186.99
Our Price £149.99



Cascade/header
69x68x17cm
RRP £186.99
Our Price £149.99

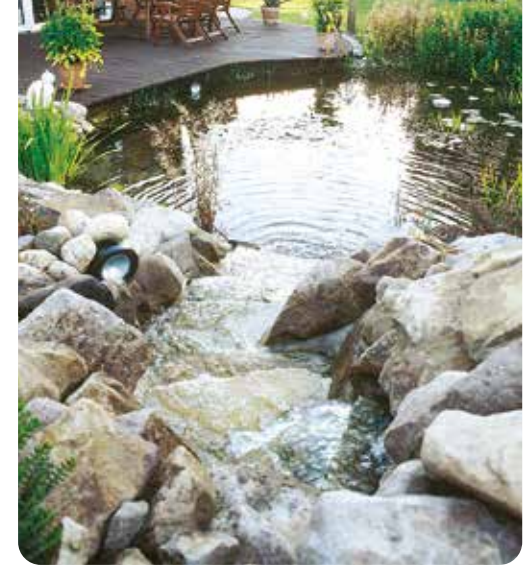

Bestseller

Large Fall
73x123x18cm
RRP £372.99
Our Price £299.99



Single Step Watercourse



Double Step Watercourse

Sandy Super Sellers Medium sized falls with discreet water entry area fed by built-in 20-40mm hoesetail - can be combined if required.

- 1 Single Step** 55x71x38 RRP £124.99 **Our Price £99.99**
- 2 Double Step** 55x90x38 RRP £165.99 **Our Price £129.99**



Fibert Frog's Top Tip

Genuine stone waterfalls look great but are incredibly difficult and heavy to work with. These realistic falls look the part and are far easier to install.

Water Courses

Rockways Rustic Slate Watercourse

This is the finest watercourse we have seen. Supplied in a rustic slate finish it looks incredibly realistic and would grace any water garden.

The course is modular so it can be run as a three piece structure (as shown) or changed to a two or four piece structure.

The top piece includes a 25-40mm hose inlet so the water feed can be disguised.

Overlapping 3 shelf feature as shown is approximately 1.7m x 1m x 0.8m LxWxH

Recommended flow rate 2400lph

1 Top - Shelf with inlet 70x105x15cm
RRP £196.99 **Our Price £169.99**

2 Middle - Shelf 70x105x15cm
RRP £196.99 **Our Price £169.99**

3 Bottom - Shelf Overhang 83x109x12cm
RRP £196.99 **Our Price £169.99**

Complete 3-piece fall
RRP £510.99 **Our Price £399.99**

4 Single Mould Fall



2 Middle Shelf



3 Base Overhang



Mix and match Options 'Top' with 'Overhang'

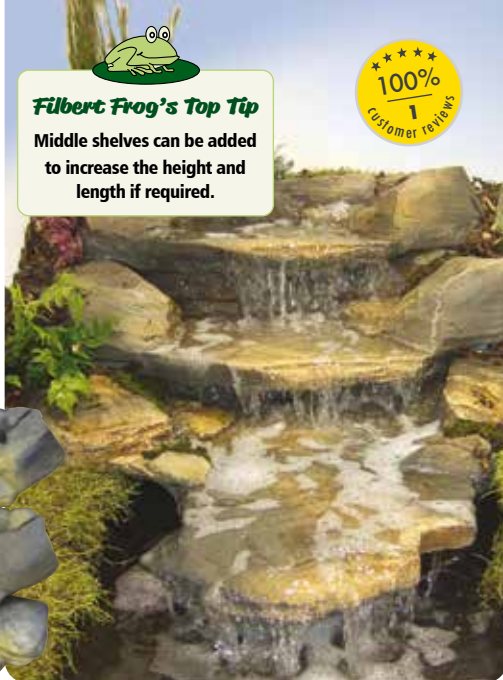

Filbert Frog's Top Tip

Middle shelves can be added to increase the height and length if required.



'Separates' Combo Deal ie, 'Top' plus 'Middle' plus 'Overhang'
RRP £590.99 **Our Price £449.99 Save £59.98**

1 Top with Inlet

Pond Waterfall Spillways

An essential aspect of any pond is the way the pumped flow of water returns into the pond. A Spillway is a great solution. They create a spectacular 'sheet' of water into your pond. Can be used to feed water into the top of a bigger waterfall (more natural effect than a tight flow created by hose outlet alone) or as a stand-alone pondside feature. Some even double up as a filter.



PondXpert Waterfall Filter 44cm

Waterfall Spillway creates a spectacular 'sheet' of water into your pond. Optional use as a filter & plant display too.

RRP £139.99 **Our Price £59.99**

Recommended Flow Rate 6000-14000 LPH

Optional integrated planting pots

Dimensions: 44x48x28cm (LWH)

Inlet size: 20-40mm

Fall includes jap matt, floating plastic media & plant pots.



Superfish Spillways

To get the most impressive results from a waterfall we strongly recommend using a spillway. This is positioned at the waterfall outlet and ensures a natural wider 'spread' of water than from hose alone. This makes the water flow far more realistic to nature's own creations.

Superfish Waterfall Spillway
19cm 20, 25mm Was £29.99 **Sale Price £19.99**

Superfish Waterfall Spillway
44cm 25, 40mm RRP £99.99 **Our Price £89.99**



Spring Sale



Black Waterfall Foam

Holds rocks together and directs water where you want it to go!

- Fills gaps and voids
- Black colour blends into shadows
- Doesn't discolour

Taiga Foam 750ml

Large can requires applicator gun.
Was £24.99 **Sale Price £19.99**

Applicator Gun

Was £29.99 **Sale Price £19.99**

PondXpert FoamFixer 500ml

Black waterfall landscaping foam. Supplied with applicator straw.

Was £19.99 **Sale Price £17.99**

3 FOR 2 DEAL £35.99

FoamFixer Cleaner £12.99

Fixer & Cleaner Set £25.99 **Save £5**



Spring Sale

All in one Pumps

Blagdon Inpond All-in-One

The Inpond from Blagdon has the added benefit of an integrated LED spotlight to illuminate your fountain. All models come supplied with a large mechanical and biological filtration area. New extended 4-model range for 2016. The new 2000 model has a smaller filtration area and fixed-angle light.



Model	Max Fish Pond Ltrs	UVC Watts	Max Flow	RRP	OUR PRICE
InPond 5in1 2000	2000	5	650	£158.99	£129.99
InPond 5in1 3000	3000	5	700	£182.99	£149.99
InPond 5in1 6000	6000	9	1500	£227.49	£185.99
InPond 6in1 9000	9000	9	3000	£275.49	£227.99



PondXpert TripleAction 15000 XL

At last the perfect All-in-One Pump designed for bigger ponds!

This new pump from the bestselling TripleAction series boasts a powerful 5200lph pump and super-large filtration chamber. Perfect for creating large fountains and/or waterfalls and keeping water crystal clear. The powerful flow can be adjusted by an integrated flow controller.



Max Flow 5200 LPH
208% Power Increase*

*versus existing TripleAction models

Modular Cartridge Feature

Your TripleAction comes complete with all filtration media. But uniquely, as well as replacement foams, entire additional filtration Cartridges can be purchased.

These cartridges simply click onto your existing pump creating greater filtration capacity and reduced maintenance.

RRP £69.99

Our Price
£34.99



Pump with additional Cartridge in position.

RRP £359.99

Our Price
£179.99

Note: Taller dimensions of this pump to accommodate extra filter media. Designed for ponds at least 26cm (10") deep.



3 Fabulous Fountains



Features:

- Integrated UVC
- Solution for ponds 2000-9000 litres
- Easy Access Filter Bed
- Adjustable Flow Control via T-piece (12/20/25mm)
- Mixed filter media: Large foam filter plus 2 x zeolite and 1 x neutral biomedias.



Bestselling All-in-One range offering maximum value for money. Choose from an extensive range of five models to find the pump that fits with the size of your pond.



Model	Max Pond Ltrs	Max Fish Pond Ltrs	UVC Watts	Max Flow	Running Costs	Max Head Height	RRP	OUR PRICE
Triple Action 2000	2000	1000	5	1000	24W	1.6m	£159.99	£79.99
Triple Action 3000	3000	1500	9	1000	28W	1.6m	£199.99	£99.99
Triple Action 6000	6000	3000	11	2000	45W	2.0m	£239.99	£119.99
Triple Action 9000	9000	4500	13	2500	59W	2.5m	£279.99	£139.99
Triple Action 15000XL	15000	7500	13	5200	55W	4.8m	£359.99	£179.99

PondXpert LED Fountain Light Ring

Submersible light designed to fit TripleAction pumps but 25mm diameter fitting will clip onto most branded fountain pumps. Can be used to attach onto 25mm pond hose to create interesting lighting effects.

- 12 LED Bulbs
- Low voltage weatherproof transformer
- 5m lv cable + 2m mains cable



LED Light Ring White RRP £59.99 Our Price £29.99

LED Light Ring Colour RRP £69.99 Our Price £34.99

LED Light Ring fits TripleAction models 2000-9000



All in one Pumps

EasyClear – The Complete Clear & Healthy Pond Solution.

Multi-function, compact pond technology solutions specially designed for smaller ponds. The traditional pond system includes a pump, UVC and external filter as separate but intertwined units. The thinking behind these new products is to combine all three of these essential items in one compact, submerged unit.

The benefits of this idea are:

- Easy no-fuss installation
- Completely hidden under the water surface - no conspicuous filter boxes, hoses or multiple electrical cable
- Just connect item to electrics, place underwater, switch on... and that's it!

Specification

Model	UVC	Max Flow	Max Pond	Recommended Uses
3000	5W	1260 LPH	3000 Ltrs	Fountain only
4500	7W	1260 LPH	4500 Ltrs	Fountain only
6000	9W	1700 LPH	6000 Ltrs	Fountain & waterfall
7500	11W	1700 LPH	7500 Ltrs	Fountain & waterfall
9000	13W	2850 LPH	9000 Ltrs	Fountain & waterfall

25mm inlet/outlet, 10m power cable & 3 fountain head displays



ONLINE VIDEO

Bestseller



Description	RRP	Our Price
EasyClear 3000	£252.49	£129.99
EasyClear 6000	£302.99	£169.99
EasyClear 9000	£383.99	£199.99



Free Gifts

EasyClear Offer

Free 5m x 25mm Hose & Clips
Free Replacement UV Bulb
worth up to £38.97



All in one Pumps

Why not add a bio-filter to your All-in-One pump system? Improves water quality & reduces pump maintenance.

All-in-One pumps are a popular convenient choice for a pond filtration system. But a weakness is that the pump foams need regular cleaning to optimise flow (this means fishing pump out of water & getting your hands dirty). The addition of a simple external filter into the cleaning-cycle reduces maintenance & boosts pond health

NEW

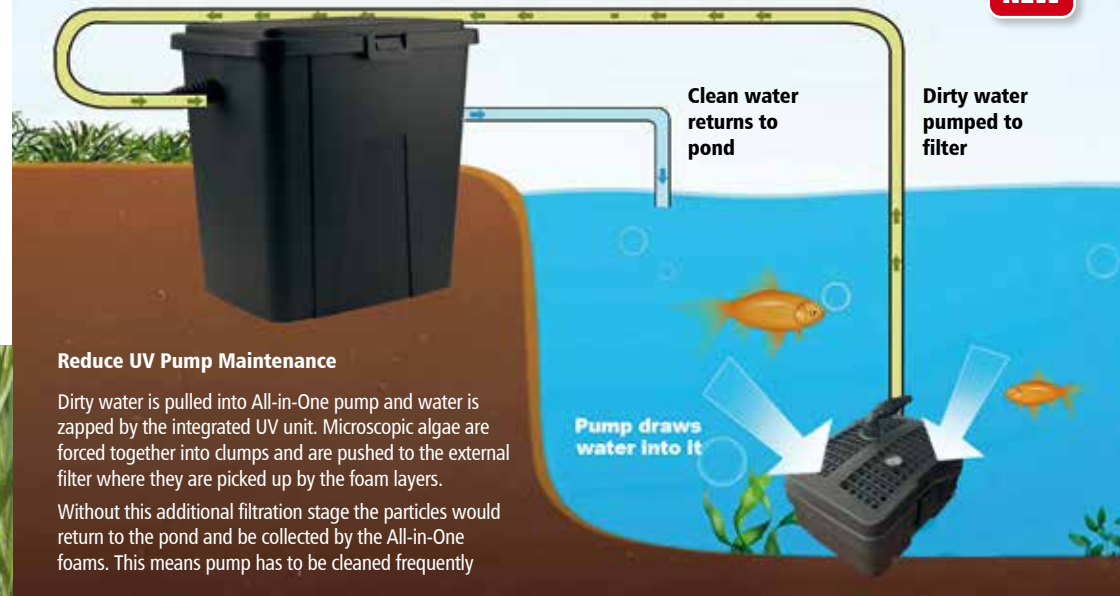

Reduce UV Pump Maintenance

Dirty water is pulled into All-in-One pump and water is zapped by the integrated UV unit. Microscopic algae are forced together into clumps and are pushed to the external filter where they are picked up by the foam layers.

Without this additional filtration stage the particles would return to the pond and be collected by the All-in-One foams. This means pump has to be cleaned frequently

PondXpert BioBox Pond Filter 4500

NEW



Outlet Pipe Extension inc. (push fit)
FREE Worth £9.99

Foams & Biomedias included

New super-value BioBox flow-through filter is the perfect addition to any All-in-One Pump by increasing filtration performance by up to 400%.

20/25mm Inlet
Dimensions: 31x23x29cm (LWH)

RRP £79.99
Our Price £39.99

- Reduces maintenance
- Easier to monitor water condition pond-side
- Less disruption of pump

BioBox + All-in-One Bundle

NEW

Pump specification see pg 31

BioBox + TripleAction 2000

Our Price £99.99 Save £48.96

Includes 3m x 20mm hose and 50mm outlet elbow Usual separates price £148.95



Includes optional-use Fountain Kit

Feature Pumps

PondXpert FeatureFlow Pumps

Comprehensive range of water feature pumps.

- Top value
- 1 year guarantee
- Flow Adjuster
- Choice of power cable length option
Choose 5m (16') or 10m (33')

These pumps pack a punch despite their compact size and are perfect for if you are looking to construct your own water feature - or as a replacement for an existing feature.



Model	Watts	Max Flow	Max Head	Hose Size (mm)	5m Cable	10m Cable
					OUR PRICE	OUR PRICE
FeatureFlow 350	6	350	0.7m	8-12	£14.99	£21.99
FeatureFlow 450	5	450	0.95m	8-12	£16.49	£23.99
FeatureFlow 750	10	700	1.4m	8-12	£19.99	£27.49
FeatureFlow 1000	14	950	1.8m	8-12	£21.99	£29.99
FeatureFlow 1200	20	1200	2.0m	12-20	£24.99	£32.99
FeatureFlow 1500	25	1500	2.5m	12-20	£31.99	£38.99
FeatureFlow 2000	45	2000	3.0m	12-20	£37.99	£44.99
FeatureFlow 3000	70	3000	3.5m	12-25	£59.99	£64.99
FeatureFlow 4000	99	4000	4.0m	12-25	£79.99	£84.99



Blagdon Auto-Off Feature Pump

This pump offers a unique benefit - it automatically switches off if the water runs low then switches itself back on once water returns.

- 3 year guarantee
- 10m power cable

Model	Watts	Hose	RRP	OUR PRICE
AutoOff 650	10	10-12	£56.49	£46.99
AutoOff 1200	10	10-12	£72.49	£58.99
AutoOff 2000	10	12-25	£106.99	£86.99

Blagdon MiniPond Feature Pumps

The perfect pump for water features. Low cost indoor version has 3m of power cable - standard outdoor model has 10m.

- 7 watts output.
- 1.0m (3' 3") Max pumping height
- Max Flow 550lph
- 1 year guarantee
- Takes hose 12-20mm (1/2"-3/4")

550i RRP £33.49 **Our Price £27.49**
550 RRP £42.49 **Our Price £37.99**



Fountain Pumps

For many an attractive fountain has come to symbolise all that is good about the perfect water garden. From the aesthetically pleasing view of an ever-changing water display to the relaxing patter of falling droplets.

A fountain pumps offers you all of this and more! Your pond and it's inhabitants will thank you too as the moving water helps to aerate the pond by increasing oxygen levels. Most fountains can do more than one job. For instance part of the water flow can be diverted to create a stream or waterfall.

They can even be used to power a filtration system - especially the 'hybrid' fountain pumps which can handle solids. Consider the fountain pump to be the star on top of the christmas tree.

Your pond is not complete without one . . .



PondXpert Fountasia Pumps

Heavy duty fountain pumps, powerful enough to power filters too!

- Dual Flow Control via sturdy 'T' Piece
- Robust strainer cage reduces maintenance
- 10m power cable (33 feet).



Model	Display	Power	Max Flow	Max Fountain	Max Head	Hose Size	RRP	OUR PRICE
Fountasia 1000	Tiered/Bell	14W	1000lph	0.8m	1.5m	12-20	£85.99	£42.99
Fountasia 1500	Tiered/Bell	25W	1500lph	1.1m	1.8m	12-20	£109.99	£54.99
Fountasia 2000	Tiered/Bell	35W	2000lph	1.3m	2.5m	12-20	£129.99	£64.99
Fountasia 3000	Tiered/Bell/Geyser	60W	3000lph	1.5m	2.8m	20/25/32	£149.99	£74.99
Fountasia 4000	Tiered/Bell/Geyser	70W	4000lph	1.6m	2.9m	20/25/32	£169.99	£84.99

PondXpert PondSpray Fountain Pump

Super value lightweight pumps, Choose from 3 fountain display effects. Flow adjuster with 'T' Piece



NEW

Model	Display	Power	Max Flow	Max Fountain	Max Head	Hose Size	RRP	OUR PRICE
PondSpray 1000	Tiered/Bell	20W	900lph	0.8m	1.5m	12-16	£59.99	£29.99
PondSpray 1500	Tiered/Bell	25W	1500lph	1.1m	1.8m	12-20	£69.99	£34.99



Fountain Pumps



Fishmate Pumps

Fishmate pumps feature anti-clog filter designs and low running costs. Available in an extensive range of sizes. They offer proven reliability and feature ceramic bearings for longevity. Pumps offer two outlets - ie, to run a fountain and/ or flow to waterfall or spitter.



2/3/4/5000 Pump.

3yr Guarantee

FISH MATE

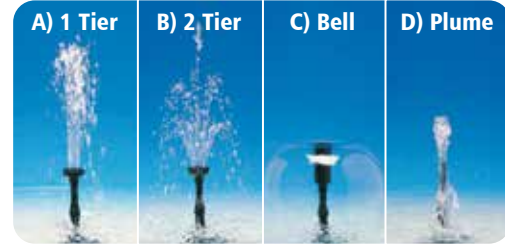

Model	Fountain Heads	Hose Size	RRP	OUR PRICE
Fishmate 1200	A,B,C,D	12-25	£52.22	£44.99
Fishmate 2000	A,B,C,D	12-25	£81.85	£69.99
Fishmate 3000	A,B,C,D	12-32	£97.94	£79.99
Fishmate 4000	A,B,C,D	12-32	£113.10	£89.99
Fishmate 5000	A,B,C,D	12-32	£179.38	£169.99
Fishmate 7000	A,B,C,D	12-32	£202.77	£149.99
Fishmate 9000	A,B,C,D	12-32	£226.18	£199.99

Cascade Pumps

The Cascade falls under the well-known Hozelock brand. Like all of this group's water gardening products it offers a high level of quality at a competitive price.

The cascade pump is an ideal all purpose pump for small to medium displays, fountains, waterfalls or ornaments.

All pumps have a double outlet meaning you can run two features from one pump. eg, a waterfall and fountain and the flow to each can be controlled independently. 3 year guarantee up to 3 fountainheads (as shown).



Bestseller



Note: No 'T' piece with 450 & 700 Outlet: 12mm 450/700, 25mm 1500/4000

Model	Fountain Heads	Fountain Height	Power Watts	RRP	OUR PRICE
Cascade 450	A,B	0.63m	10W	£100.99	£44.99
Cascade 700	A,B,C	0.75m	13W	£127.99	£49.99
Cascade 1500	A,B,C	1.2m	33W	£173.99	£74.99
Cascade 4000	A,B,C	1.6m	44W	£268.99	£114.99

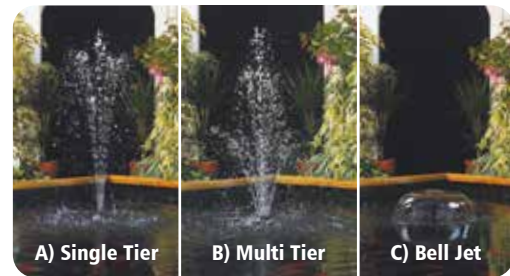

Solar - Fountain Pumps

PondXpert SunnyPump

Super value pumps work when sun shines

PondXpert SunnyPump Island 180

Fun floating solar fountain with integrated solar panel Works in direct sunlight.

Max Flow 180lph 1.4W solar panel.

RRP £59.99 **Our Price £29.99**

- No outdoor power required
- Free running cost
- Outlet: 10mm



PondXpert SunnyPump 160

Max flow 160lph, 1.4W panel. Max fountain height 0.35m

RRP £49.99 **Our Price £24.99**



PondXpert SunnyPump 300

Max flow 300lph, 3W panel. Max fountain height 0.65m.

RRP £69.99 **Our Price £34.99**

PondXpert SunnyPump 250

Solar Pump with extra oomph!

Works in direct sunlight. 2W solar panel.

Maximum fountain height 60cm.

Maximum flow rate 250lph.

RRP £59.99 **Our Price £29.99**

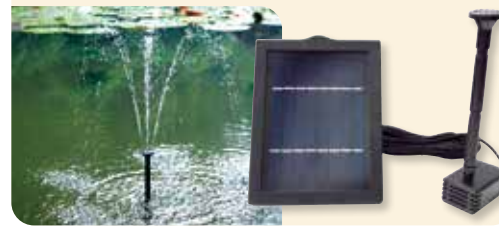

PondXpert SunnyPump 900

Super powerful solar fountain pump. Feature-packed, operates in direct sunlight only.

Max Flow 900lph 10W solar panel Max fountain height 2m.

RRP £199.99 Was **£99.99** Sale Price **£79.99**



Jumping Jet Solar Pumps



Duck Spitter

13 x 23 x 17cm (LWH)

RRP £49.99

Our Price £24.99



Turtle Spitter

16 x 23 x 11cm (LWH)

RRP £49.99

Our Price £24.99



Sitting Frog Spitter

17 x 21 x 22cm (LWH)

RRP £49.99

Our Price £24.99

Frog Spitter (Small) 14 x 11 x 21cm (LWH)



Recommended optimal pump match SolarPulse 250

RRP £49.99 **Our Price £24.99**

Frog Spitter (Large) 33 x 24 x 33cm (LWH)



Recommended optimal pump match SolarPulse 500

RRP £69.99 **Our Price £34.99**



All PondXpert Spitters supplied with 8mm & 12mm hose (1.5m lengths)

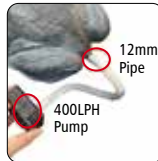
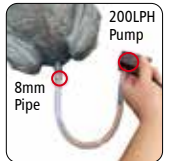

Koi Spitter (Large)

42 x 18 x 27cm (LWH)

RRP £79.99

Our Price £39.99

Recommended optional pump partner SolarPulse 500

Jumping Jet Solar Pumps

We love our solar pumps but sometimes feel that the water jet display can become a bit predictable. These new solar pumps can be selected to emit a spitting truncated jet of water as well as the usual continuous flow.

Multi-feature premium solar pumps with lithium battery-back. NEW Mains charging option via USB (cable supplied*)

* 500 model only

All Pulse Pumps now supplied with **FREE fountain kit worth £9.99**



PondXpert SolarPulse 250

Includes battery, fountain kit & USB charging point.

Max flow 500lph, 9W panel.

Max fountain height 0.90m

Max water lift: 1.6m

Battery: Lithium 7.4v

Outlet: 12mm

RRP £169.99

Our Price £79.99

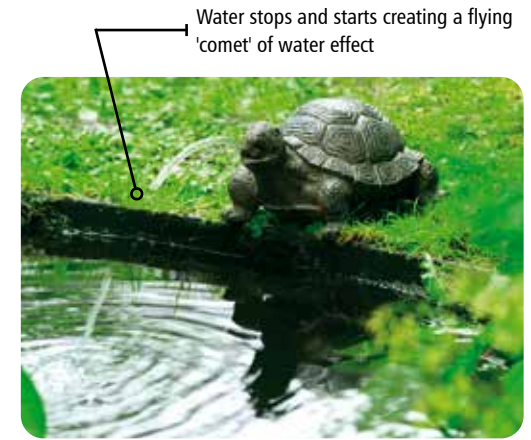

Water stops and starts creating a flying 'comet' of water effect

PondXpert SolarPulse 250

Includes battery and fountain kit

Max flow 250lph, 2W panel.

Max fountain height 0.60m

Max water lift: 1.5m

Battery: Lithium 3.7v

Outlet: 8mm

RRP £119.99

Our Price £59.99

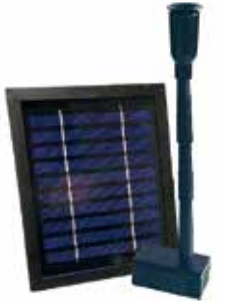

Spitter + Solar Pump Bundle Deals

Small Frog Spitter + Solar Pulse 250

Usual Price £84.98 **Deal Price £69.99** You Save £14.99

Large Koi Spitter + Solar Pulse 500

Usual Price £119.99 **Deal Price £99.99** You Save £19.99

More Spitter Bundles Online

eg, Small frog + SunnyPump 250 **£49.99**

Note: This combination would only operate when sun is shining

Solar - Fountain Pumps

SolarShower Float 180 LED

Floating solar pump with back-up battery and LED lights. Includes fixing sticks to keep pump in position (useful if used in bird-baths to keep pump in the middle). 2.5W panel. Max. fountain height 50cm.

RRP £139.99 Was £69.99 **Sale Price £34.99**



SolarShower Float 200 LED

Floating solar pump with back-up battery and LED lights. Includes remote control. Max flow 200lph. Max fountain height 60cm (2'). 4.4W panel - Power Boost 3W

RRP £139.99 **Our Price £69.99**



PondXpert Solar Power Extension Cable 5m

Enables greater choice of where panel can be positioned.

RRP £15.99 **Our Price £7.99**



Solar Pumps - Battery Boosters

The solar pumps shown on the opposite page (which are also used to power the features on this page) contain lithium batteries that can be powered up using mains electricity.

This is particularly useful during an elongated period of cloud or if the feature is to be run indoors (eg, in a conservatory).

5v Adapter

(SolarShower 200)

RRP £19.99

Our Price £9.99

9v Adapter

(SolarShower 300 to 800)

RRP £25.99

Our Price £12.99



PondXpert SolarShower Pumps

Next Generation solar pumps from PondXpert boast the latest lithium battery technology.

Model	Solar Panel Power	Max Water Lift	Mains Charger	Lithium Battery
SolarShower 200	4.5W	0.8m	5V	3.7v
SolarShower 300	5W	1m	9V	7.4v
SolarShower 400	5W	1.2m	9V	7.4v
SolarShower 600	7W	1.4m	9V	7.4v
SolarShower 800	13W	2.0m	9V	7.4v

Feature-packed

Battery only run-time: 2-8 hrs depending on flow.

A selection of 4 different fountain head attachments are included with every pump to enable creation of different effects.

Auto nighttime illumination with optional 4 bulb LED lighting ring (supplied). Inc. 5m panel-to-pump power cable.

Pushing water through a feature / small waterfall

As well as creating a fountain display the pumps can be used to power a spitter or water feature. We recommend the use of 10mm diameter connection hose.

Now HALF PRICE

10mm hose 1 metre length	£4.99	£2.49
10mm hose 2 metre length	£8.99	£4.49
12mm hose 1 metre length	£5.99	£2.99
12mm hose 2 metre length	£9.99	£4.99

Solarshower 200/300 take the 10mm hose

Solarshower 400/600/800 take the 12mm hose

Latest Technology: Works in sun, cloud . . . even indoors!

Solar Panel • Lithium Battery • LED Lights • Plug into Mains*



SolarShower 200

Max Flow: 200 Ltrs per hr
Max Fountain Height: 44cm

RRP £119.99

Our Price £59.99



SolarShower 300

Max Flow: 300 Ltrs per hr
Max Fountain Height: 60cm

RRP £139.99

Our Price £69.99



SolarShower 400

Max Flow: 400 Ltrs per hr
Max Fountain Height: 120cm

RRP £159.99

Our Price £79.99



SolarShower 600

Max Flow: 600 Lph
Max Fountain Height: 140cm

RRP £199.99

Our Price £99.99

SolarShower 800

Max Flow: 800 Lph
Max Fountain Height: 140cm

RRP £239.99

Our Price £119.99

Power Boost 9W 13W

All Fountains illuminate at night!



PondXpert SolarShower 1600

Extra-Power solar fountain pump to create bigger display. This pump utilises twin solar panels (2 x 10W) to produce a higher maximum flow of 1600 LPH. The fountain can be controlled by use of the Control Unit which houses the 12V battery.

- High power 1600LPH flow
- LED light for night-time usage
- Battery back-up enables pump to work in sun, shade or at night
- Mains adapter available to boost power when sunlight in short supply
- Features 'Bell' and 'tiered' fountain heads
- Connect 12mm hose to divert flow to a pond or water feature

RRP £399.99 Usually £199.99 **Sale £149.99** 12V Mains Adapter £14.99



Water Lift Max: 2.7m
Max Fountain Height: 1.8m
Max Flow: 1600LPH
Power: 20W (2x10W)
Panel to Pump Cable 5m Length



PondXpert SolarShower 3000



Set includes mains charger & Control Unit housing an 18-21V battery

- Lift Max: 3.2m
- Max Flow: 3000LPH
- Max Power: 50W
- Three hosedails supplied 20mm, 25mm, 32mm.

RRP £799.99 Was £399.99 **Our Price £299.99**



PondXpert Solar XL 20mm Filter System

Create a wireless pond powered purely by the sun! Box Filter, hose and 5W Solar UVC

RRP £199.99 **Our Price £99.99**



COMBO DEAL!

Buy SolarShower 3000 Pump & 3000 Filtration System together save £50. ~~£399.99~~ **Our Price £349.99**

Buy SolarShower 1600 Pump & XL (12mm) Filtration System together save £20 ~~£249.98~~ **Our Price £229.98**

Solar - Fountain Pumps

PondXpert SolaFlow Fountain Pumps

New pumps from PondXpert destined to become a bestseller. Added on-board chip intelligence allows extra features:

- ✓ Timer/Memory**
Three modes of operation - 'Auto' '8hr' and '12hr'. Set daily start time for pump to run.
- ✓ Remote Control**
User has the option of operating the pump remotely with a multi-function remote control unit.
- ✓ Premium Lithium Battery Back-up**
Other XL solar pumps use lead-acid batteries

Additional standard features:

Auto-illuminating LED lights (4x bulbs, bright white).

Choice of fountain displays - 'tiered' or 'bell'



Outlet size:

10mm 200/300
12mm 500-1750

Note: 200 & 300 models not available until August 2026

Model	Max Flow	Power	Max Head	Max Fountain	Lithium Battery	Max Run-Time	Adapter (not inc.)	RRP	OUR PRICE	Adapter (not inc.)
SolaFlow 200	200LPH	5W	1.2m	0.53m	3.7v-4AH	15hrs	5v	£149.99	£74.99	£9.99
SolaFlow 300	300LPH	7W	1.4m	0.63m	7.4v-2AH	15hrs	9v	£179.99	£89.99	£12.99
SolaFlow 500	500LPH	10W	1.1m	2.3m	7.4v-4AH	21hrs	9v	£239.99	£119.99	£12.99
SolaFlow 1100	1100LPH	22W	1.7m	1.4m	11.1v-4AH	16hrs	13v	£299.99	£149.99	£14.99
SolaFlow 1750	1750LPH	24W	2.6m	2.2m	14.8v-4AH	12hrs	18v	£399.99	£199.99	£19.99

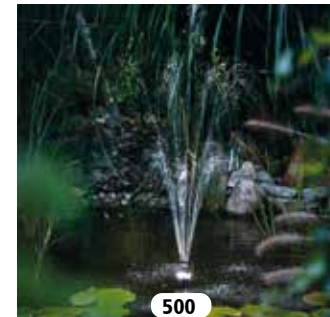

Remote Control Included

NEW

Solar - UVC

Those clever engineers at PondXpert have come up with a new pond product we believe is a world first! A solar powered ultra-violet clarifier to stop pond water going green.



Panel Power: 3W
UV Bulb Power: 5W
Panel Lead Length: 5m
Inlet size: 12mm
Battery: Lithium

EXCLUSIVE

PondXpert Solar UVC 5W

The Solar UVC is designed to illuminate for two hours per day. Simply set once then the onboard memory will ensure this same start time is selected daily. The Clarifier unit itself is submersible and designed to be placed underwater with the Panel positioned dry/pond-side. The 5 Watt UVC bulb is powered by the sun with excess solar energy stored in the lithium battery.

RRP £159.99 **Our Price £79.99**

This technological breakthrough means that 'wire-free' water gardening becomes a reality!



Note: Solar UVC needs to be paired with a pump to push water past the UVC bulb. This pump power should be 400 to 1000LPH in flow strength.

Solar - Filter

Most solar pond pumps are designed to create a fountain - if the fountain is disconnected and hose attached to the outlet the water can be fed to a different use (eg, small waterfall, pondside spitter or UVC). BUT Solar pumps tend to be small and light in weight and their small impellers that can get clogged with dirt very easily. Without protection we've found they aren't really suitable at producing a reliable flow for a pond.

To use a solar pump for this alternative non-fountain use it is strongly advised that an underwater filter be used. This holds the pump steady in upright position and collects dirt and debris before they reach the pump.



PondXpert Solar Filter Box (TripleAction)

The filter box used in the PondXpert TripleAction Solar pumps is available for separate purchase. It is similar in design and size to the PondXpert Eco-Filter 2000 shown above but comes complete with gravel and biomed (biological cleaning and ballast). Suitable for all solar pumps.

RRP £99.99 **Our Price £49.99**



Model	Pond Size Lts	UV Watts	RRP	OUR PRICE
EcoFilter 2000	2000	0	£79.99	£39.99
EcoFilter 4000	4000	0	£99.99	£49.99

Both the above filters need the addition of ballast to keep them submerged. (eg, **Gravel £6.99** or **Zeolite £16.99**).

Solar All-in-One Pond Filtration System

Taking advantage of the latest technological solar UVC and filtration breakthrough we are proud to be able to bring to your attention the first solar 'All-in-One' Pumps.

Now the water in a small pond can be kept clean and healthy without any mains electric wiring or running costs!

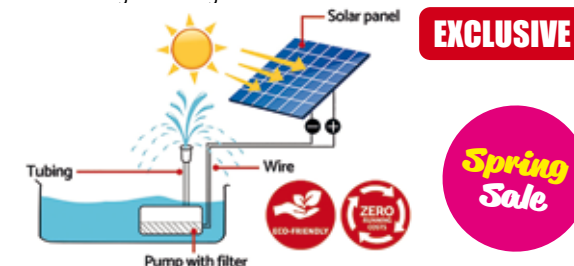

EXCLUSIVE

Spring Sale

Solar Powered Pumping with renewable energy

- ✓ Enables a pond to be positioned anywhere without need to access mains electric
- ✓ The first pond filtration system with zero running costs!
- ✓ Mains adapter inc. for indoor battery charging during prolonged periods of poor weather. (800=9v, 1600=13v)

'Exploded' view of filter



Model	Max Pond Lts	UV Watts	Max Flow	Panel Power	Lithium Battery	RRP	Was	SALE PRICE
TripleAction Solar 1200H	1200	5W	650LPH	12W	N/A	£239.99	NEW	£119.99
TripleAction Solar 800	800	5W	450LPH	9W 12W	7.4v-4AH	£299.99	£149.99	£129.99
TripleAction Solar 1600	1600	5W	850LPH	12W 14W	11.1v-4AH	£399.99	£199.99	£169.99

TripleAction HYBRID 1200

NEW

New version with a fresh approach to consider.

No battery is included which enables product price to be reduced. But there is no compromise on quality. Clever on-board circuitry means this unit is powered by the sun - but if cloudy (or during night power) source switches to mains electric. Similar to thinking behind 'Hybrid' motor engines it means the greenest power solution is deployed with priority with traditional energy source backing it up.

Hybrid inverter/solar charger

Sunny - Power drawn from solar

Cloudy - Energy shared between mains/solar

Night - Power from mains

Hyrid model compromises

This pump version needs access to mains power. Mains energy is not free - but low 12W power means running cost is minimal.



PondXpert SolarFalls Water Features

Terracotta Cascade

32x32x53cm (LWH)
Inc. 200LPH Pump

RRP £199.99
Was £99.99

Sale Price £79.99

**pondXpert
SolarFalls**



SolaBall Grey

27 x 27 x 56cm (LWH)
Inc. 200LPH Pump

RRP £199.99
Was £99.99

Sale Price £79.99



All these features include
SolarShower 200 Pump
see pg 41

Stepped Frog Cascade

45 x 36 x 64cm (LWH)
Inc. 200LPH Pump

RRP £239.99
Was £149.99

Sale Price £95.99



Cascading Jugs

22 x 22 x 61cm (LWH)
Inc. 200LPH Pump

RRP £299.99
Was £149.99

Sale Price £119.99



Last Few Remaining

ZERO RUNNING COSTS • HALF PRICE RRP • USE INDOOR OR OUT • EASY ASSEMBLY

All PondXpert SolarFalls water features include: solar pumps (battery-back up), hose and LED lights

Did you know?

No 'shrinkflation' here!

With PondXpert you can be assured that you will receive a top notch water feature. All models showcased here have 'proper' dimensions - ie, substantial size of features are designed to make the correct visual impact in your garden or conservatory. PondXpert have noticed a worrying trend in the market to reduce the dimensions of water features to reduce cost but have decided that this is a false economy.

PondXpert: Reducing prices not quality

The pumps used to power these features are the same quality bestselling pumps we sell individually:

SolarShower 200 £59.99 see pg 41

SolarShower 300 £69.99 see pg 41

Proven quality & reliability.

Plus you gain access to a full range of pump spares and accessories that we offer. eg:

SolarShower 200 5v Mains Adapter £9.99

SolarShower 300 9v Mains Adapter £12.99

TripleTumble

39x39x72cm (LWH)
Inc. 200LPH Pump.

RRP £299.99
Was £149.99

Sale Price £119.99



Elegance Classical Fountain

58x58x86cm (LWH)
Inc. 300LPH Pump.

RRP £379.99
Was £189.99

Sale Price £149.99

Stands nearly 3 feet tall

**PondXpert
Water Feature
Cleaner £12.99**



These larger features include the SolarShower 300 Pump see pg 41

Contemporary BirdBath

41x39x71cm (LWH)
Inc. 300LPH Pump.

RRP £339.99
Was £169.99

Sale Price £134.99



Filter Pumps



Perfect 'Starter' Pump. Solids-handling with energy-efficient motor.

PondXpert MightyMite

Super solution for small ornamental pond owners. These reliable pumps are designed to be run 24/7 pushing water to a filter and/or waterfall.

- Relatively low running costs. Energy efficient motors.
- Extremely quiet in operation.
- Solids handling ability (4mm max particle size).
- Thermal protection - auto-off if impellor blocked.



Easy tools-free access to pump. Makes maintenance quick & easy!



Multiple hosetails included so a range of hose sizes can be connected.



Perfect pump for powering pond filters and/or small waterfalls.

Model	Max Flow LPH	Flow @ 1m	Max Pumping Height	Watts	RRP	OUR PRICE
MightyMite 1000	1000	300	1.5m	20	£69.99	£34.99
MightyMite 1500	1500	850	1.8m	25	£89.99	£44.99
MightyMite 2000	2000	1100	2.0m	35	£99.99	£49.99
MightyMite 2500	2500	1700	2.7m	45	£109.99	£54.99
MightyMite 3000	3000	2100	3.0m	55	£129.99	£64.99

- 10m length power cable
 - Three hosetails included:
- 1000 12/20/25mm
1500 to 20/25/32mm
3000



Filter Pumps



"Pump works great with good flow rate. Cage is very easy to open (Probably best on market) with very easy clips for maintenance purposes. Spot on!"

Customer Feefo Review July 2017

PondXpert UltraFlow

At last we have found a pump that 'ticks all the boxes'. Consider the following features:

- Ultra-low running costs.
- 'Auto-Off' function if water level drops too low.
- Choice of 10 models enables user to make a refined choice.
- Alternative inlet feature (blanked off on initial set-up).
- Alternative inlet can be attached to a skimmer or satellite strainer if required.
- Set includes 2 multi-stage hoses (25/32/38/40mm).
- Can be run submersed or 'dry' (ie, suitable for pondkeepers running a gravity-fed system).
- Designed to run 24/7, 365 days per year (handles 6mm solid particles).
- Tool-free access to pump inside filter cage (easy to access and clear out any blockages).
- Three year guarantee
- Carry handle (very useful when lifting pump out of pond)

Filbert Frog's Top Tip

Check your current pump power ratings. An old pump may have a high wattage and these are expensive to run. For instance a 'typical' 5yr old 8000lph pump could be 180W. The UltraFlow is just 70W. Running 24/7 the UltraFlow could save you £240 per year off your electricity bill*.

Pump Dimensions:

LWH: 25 x 18 x 11.5cm

Relatively compact - suits any size of pond

* Electricity costs vary - please check with your current supplier. Example given is cost of £0.25pkwh.

All pumps accept hose 25 / 32 / 38 / 40mm and come complete with 10m outdoor power cable

Model	Max Flow LPH	Flow @ 1m	Max Pumping Height	Watts	RRP	OUR PRICE
UltraFlow 3000	3000	1600	2.0m	10	£179.99	£89.99
UltraFlow 3600	3600	2400	2.8m	20	£199.99	£99.99
UltraFlow 5300	5300	3900	3.3m	30	£239.99	£119.99
UltraFlow 6000	6000	4725	4.2m	40	£259.99	£129.99
UltraFlow 8000	8000	6900	5.6m	70	£299.99	£149.99
UltraFlow 10000	10000	8550	6.0m	80	£339.99	£169.99
UltraFlow 12000	12000	11400	6.5m	100	£359.99	£179.99
UltraFlow 14000	14000	12450	7.0m	120	£379.99	£189.99
UltraFlow 16000	16000	14775	7.5m	155	£399.99	£199.99
UltraFlow 20000	20000	17250	6.0m	180	£459.99	£229.99

Filter Pumps

Hozelock Aquaforce

One of our bestselling pumps from a trusted UK brand

The Aquaforce is a reliable solids-handling pump that will work 24/7. There is a choice for every pond size and larger models (6000+) come complete with a second inlet that can be attached to a skimmer or satellite strainer cage.

- Highly economical 'eco' motor.
- Unique Wildlife Protection System: Intake holes can be reduced to 2mm to prevent tadpoles, newts and small fish getting into the cage.
- Smaller pumps (1000-4000) can handle solids up to 6mm
- Larger pumps (6000-15000) can handle solids up to 10mm
- 3 Year Guarantee



FREE Gift with all Aquaforce Pumps
5m length of 40mm pond hose & clips.
(Worth £34.78)



Price Match Promise - Lowest UK Price Guaranteed**

Model	Max Flow LPH	Flow @ 1m	Hose	Watts	RRP	OUR PRICE
Aquaforce 1000	1000	700	20-40	25	£191.99	£119.99
Aquaforce 2500	2500	1850	20-40	30	£231.99	£134.99
Aquaforce 4000	4000	3000	20-40	50	£282.99	£167.99
Aquaforce 6000	6000	5550	20-40	65	£389.99	£219.99
Aquaforce 8000	8000	7400	20-40	95	£464.99	£249.99
Aquaforce 12000	12000	10800	20-40	130	£552.99	£299.99
Aquaforce 15000	15000	13100	20-40	180	£624.99	£349.99



Fibert Frog's Top Tip

Good news! UK Electricity prices have reduced! Typical Kwh price now 24.67p a big drop from the peak seen in 2023 (33.2p). But with energy costs running high it's still a wise decision to upgrade to an ultra-low energy pump (eg, PondXpert UltraFlow) - this will dramatically reduce running costs. Even better, consider installing a variable flow pump which can reduce bills further still!

Bestselling variable flow pumps New for 2021 is a range of accessories to make these pumps even better.

PondXpert VariFlow Fountains

Create a 'geyser jet', 'tiered fountain' or 'bell jet'. Kit includes a T Piece with 20/25/32mm hosetail.

10000 Fountain RRP £39.99 **Our Price £19.99**

20/30000 Fountain RRP £59.99 **Our Price £29.99**



VariFlow 30000 Geyser Fountain in action

VariFlow Expanded Strainer Cages

Reduce maintenance by plugging in one of these large strainer cages to your VariFlow Pump.

10000 Strainer RRP £39.99 **Our Price £19.99**

20/30000 Strainer RRP £49.99 **Our Price £24.99**



Filter Pumps - Variable Flow



PondXpert VariFlow Pond Pump

- Create & control dramatic water displays
- Pumps automatically switch off when low water detected
- Save £££s** by reducing energy bills (perfect for winter running)

Improved 'Sine' motor

Sine Wave Technology
Higher head heights

Better reliability & quieter operation

Model	Max Rate	Power Use	Max Height	RRP	OUR PRICE
VariFlow 10000	4860lph to 10000lph	30 - 85 watts	5.5 metres	£379.99	£189.99
VariFlow 20000	13864lph to 18500lph	80 - 200 watts	7.5 metres	£499.99	£249.99
VariFlow 30000	16860lph to 25000lph	130 - 360 watts	10.0 metres	£759.99	£379.99

Multi-Hosetail Included: 25/ 32/ 40/ 50mm (1-2")
(10k version 20-40mm Hosetail included)
10m power cable length plus 2m to controller

Reduce flow = reduce energy savings

Turn 10,000lph pump to 4860lph save £124 per year.

Turn 20,000lph pump to 13864lph save £263 per year.

Turn 30,000lph pump to 16860lph save £500 per year*.

1 Pump - 23 controllable flow rates

Never before has a pondkeeper been able to control the flow like this (well, not without paying many hundreds of pounds for pro kit). VariFlow can be used submersed or 'dry'.

(*savings based on 25p/kWh)



3 Variflow Settings in action

PondXpert VariFlow XL

Introduced in 2023 these super powerful variable flow pumps dedicated to the serious pondkeeper. These ultra-powerful pumps are designed for those who need a massive amount of flow.

The 52,000 LPH model is the most powerful pump we have ever sold.

The 42,000 LPH can operate at 30,000 LPH at at just 105W running costs.

3 inch inlet/outlet Can be run dry

Supplied with a free 2" pipe conversion kit. This includes reducers and optional strainer cage as shown in image.



Model	Flow Rate	Power Use	Max Height	RRP	OUR PRICE
VariFlow 42000	32060 to 42000 LPH	105 - 450 Watts	6.5 metres	£1099.99	£549.99
VariFlow 52000	30658 to 52050 LPH	180 - 600 Watts	8.5 metres	£1199.99	£599.99

PondXpert VariFlow Strainer+ Pump

These variable flow pumps dedicated to the traditional ornamental pond owner. VariFlow pumps are growing in popularity with many first adopters running them 'dry' for use with koi ponds. These new Strainer+ models offer all the benefits of the original VariFlow but come complete with a strainer cage for submersible use. (They can be still run dry if required).

- 3 Year Guarantee
- 2 inch outlet
- 25/32/38/40mm outlet
- 10m Power Cable
- 3m Cable to control unit.



Model	Flow Rate	Power Use	Max Height	RRP	OUR PRICE
VF Strainer+ 5000	2800-5000 lph	24 - 43 Watts	4.0 metres	£359.99	£179.99
VF Strainer+ 10000	4400-10000 lph	30 - 92 Watts	5.6 metres	£419.99	£209.99
VF Strainer+ 20000	9700-20000 lph	52 - 205 Watts	7.5 metres	£539.99	£269.99



Adjustable 2" outlet for virtually any direction



Convenient handle built into the outer cage



Optional large strainer cage

PondXpert VariSmart Pumps

Variable flow pumps with advanced on-board electronic intelligence (SmartPump Technology)

- Ten minute Pause/feeding function
- Lockable flow setting positions
- Auto-off with blockage protection
- Audible alarm if blockage detected
- Memory function - restart position
- 4mm solids handling (11mm 35000)



Submersible installation



'Dry' installation



NEW



Blue 'feet' click out allowing pump to stand on its end

32mm elbow included

Spring Sale

Model	Flow Rate	Power Use	Height	Hose	RRP	Post Event Price	SALE PRICE
VariSmart 8000	3500-8000 lph	18 - 80 Watts	5.4m	20/25/32	£299.99	£149.99	£129.99
VariSmart 15000	7500-15000 lph	37 - 180 Watts	7.0m	25/32/40	£399.99	£199.99	£169.99
VariSmart 35000	13000-32000 lph	45 - 450 Watts	12.0m	32/38/50	£999.99	£499.99	£449.99

PondXpert VariSmart 35000 (Pump available mid-June 2026)

35000 Model is extra heavy-duty build. Comes complete with carry-handle and stainless steel water intake grill (strainer cage). Can be operated dry or submersed - strainer cage can be removed with alan key supplied.

Extra length power cable from controller to pump (10m + 10m in total).

Dimensions: 46 x 18 x 22 (LWH cm)

VariSmart 35000

RRP £999.99

Our Price £449.99

Pump in 'dry' mode of operation strainer cage removed



NEW



Pond Filtration

How it works

Your pond pump is designed to suck up dirty pond water and push it to a waterfall and/or filter. Filtration is the process by which your pond is cleaned of impurities. Once the water reaches the filter it usually passes through three key stages:

1 UVC Radiation

If your filter has a built-in UV unit this exposes the water to UVC rays which cause microscopic single cell algae to flocculate (that is to stick together to form larger pieces). This action causes this suspended algae to die and fall to the bottom of the pond. This clears the water and the solid particles are sucked up by the pond pump.

2 Mechanical Filtration

Dirt such as fish waste and algae particles generated by UVC radiation are caught in physical mechanical barriers. Foams are a typical example - often with multiple grades to catch even the smallest pieces.

3 Biological Filtration

Dirt-free water then passes through a bed of bio-media. This material will often have a multi-surface appearance for healthy bacteria to stick to and thrive. Such bacteria break down ammonia into Nitrite. Nitrite is broken down into nitrate.



Flow-through Filters **UVC Included**

Lotus Green Genie

Popular entry level filters. Inlet tap to regulate flow into tank.

Inlet Size:
20/25mm 2500 to 12500
20/25/32mm 18000 to 48000
Outlet Size:
32mm 2500 to 12500 (x2 on 12500)
50mm x 2 18000 to 48000.



Add a pump & save £££'s

Model	Pond Size Lts	UV Watts	RRP	OUR PRICE	Set Name	Pump in Kit	OUR PRICE	Save
Green Genie 2500	2000	7	£126.99	£109.99	GG 2500 Set	MightyMite 1500	£139.99	£14.99
Green Genie 3500	3000	10	£142.99	£119.99	GG 3500 Set	MightyMite 2000	£149.99	£19.99
Green Genie 6500	4000	18	£152.99	£129.99	GG 6500 Set	MightyMite 2500	£159.99	£24.99
Green Genie 12500	6000	18	£182.99	£159.99	GG 12500 Set	FlowMaster 3500	£179.99	£49.99
Green Genie 18000	9000	18	£229.99	£199.99	GG 18000 Set	FlowMaster 4500	£219.99	£59.99
Green Genie 24000	12000	25	£289.99	£249.99	GG 24000 Set	UltraFlow 6000	£319.99	£59.99
Green Genie 30000	15000	25	£382.99	£329.99	GG 30000 Set	UltraFlow 8000	£399.99	£79.99
Green Genie 48000	20000	2 x 25	£469.99	£399.99	GG 48000 Set	UltraFlow 10000	£469.99	£99.99
Green Genie 60000	20000	2 x 40	£547.99	£439.99	GG 60000 Set	UltraFlow 14000	£529.99	£99.99

Dimensions (cm LxWxH) 2500/3500/6500 - 38 x 27 x 30, 12500 - 46 x 32 x 41, 18000/24000 - 55 x 45 x 31, 30000/48000 - 64 x 46 x 46

Main types of pond filters available:

Flow-through Filters (pages 55-57)



The traditional 'Box' filter sits pondside or at the top of a waterfall. Pond water is pushed into one end and returns via gravity from the other. These filters are generally larger and provide a massive area of filtration media to cope with larger ponds.

Koi & Large Capacity Filters (pages 62-64)

Pressure Filters (pages 58-61)



A more modern approach is to house the filter media into an airtight cannister. The water enters the filter under pressure and leaves it under pressure allowing the filter to be hidden. Great for smaller ponds - these filters provide maximum landscaping opportunities.

Lotus Clear Pond Filters

Advanced 7 Stage filter with larger UVC and quick action back flush (de-sludge system)

- Red Brush chamber for heavy solids
- Blue Foam cartridges chamber
- Green, white & blue graded foams
- Top outlets - can be partly buried
- Good enough filter for koi/mixed stock. (½ volumes for koi in table)



Dimensions (cm)
18 - 46 x 30 x 41, 25 - 54 x 40 x 39,
50 - 64 x 46 x 49, 80 - 78 x 58 x 69

Add a pump & save £££'s

Model	Pond Size Lts	UV Watts	RRP	OUR PRICE	Recommended Pump	OUR PRICE	You Save	Upgrade to Hz Aq'force Pump	OUR PRICE	Save
Clear Pond 18	9000	18	£244.99	£209.99	UltraFlow 3000	£249.99	£49.99	Aquaforce 4000	£319.99	£49.99
Clear Pond 25	18000	25	£359.99	£309.99	UltraFlow 6000	£369.99	£69.99	Aquaforce 6000	£449.99	£89.99
Clear Pond 50	27000	50	£514.99	£444.99	UltraFlow 10000	£519.99	£94.99	Aquaforce 8000	£619.99	£84.99
Clear Pond 80	36000	80	£659.99	£549.99	UltraFlow 14000	£629.99	£109.99	Aquaforce 15000	£799.99	£99.99



PondXpert BioBox Pond Filter 4500

RRP £79.99 **Our Price £39.99**

FREE Outlet Extension Pipe included (worth £9.99)

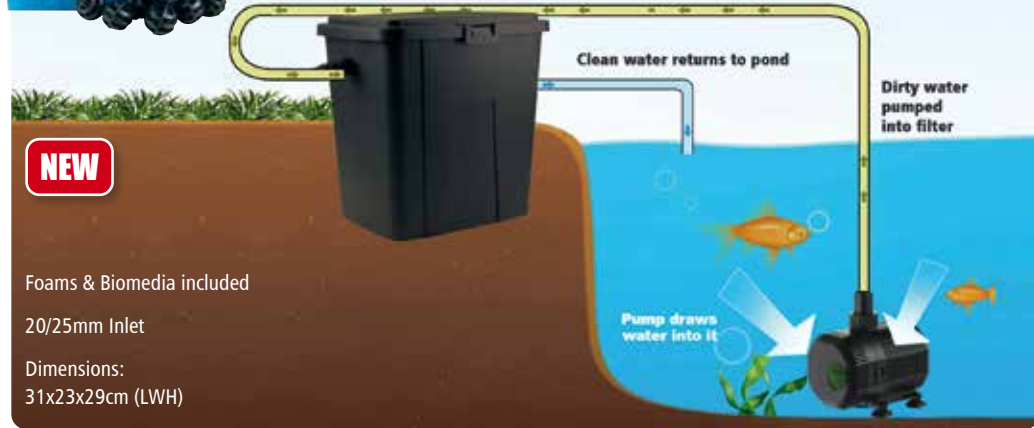

PondXpert BioBox Bundles All Sets include 20mm hose x 3m, hoseclips & 50mm outlet extension elbow



BioBox Pump & Filter Set

RRP £199.99 **Our Price £79.99**

Includes PondForce 2300 filter pump.
Separates price £103.95 Save £23.96



BioBox & All-in-One Pump

RRP £199.99 **Our Price £99.99**

Includes TripleAction 2000 UV Pump.
Separates price £148.95 Save £48.96



BioBox Pump & Pump & UVC

RRP £219.99 **Our Price £109.99**

Inc 11W UVC & PondForce 2300 pump
Separates price £153.94 Save £43.95

BioBox Solar Sets

Create a solar-only pond. Zero energy costs & pond can be sited anywhere!

Solar XL UV Set 1600

RRP £499.99 **Our Price £229.98**

Solar XL UV Set 3000

RRP £699.99 **Our Price £349.99**

For further info on our exciting solar only pond solutions see pg 42

(Inc. Solar UVC, BioBox filter, Solar 1600 pump & 12mm hose)

(Inc. Solar UVC, BioBox filter, Solar 3000 pump & 20mm hose)



PondXpert FiltoBox

Introduced in 2010 these flow-through filter boxes consistently top our bestsellers chart. Feature-packed yet very competitively priced it is no wonder they are a firm favourite with our customers.

- Top outlets mean filters can be buried up to 2/3 of height
- High quality construction
- Sludge drain for easy cleaning
- Easy Access to UVC.



Save £50 on all FiltoBox

Inlets 25-40mm, Outlets 50mm (70mm on 12000)

Dimensions (cm LxWxH)

6000 - 37 x 27 x 39, 12000 - 55 x 38 x 44, 12000 - 40 x 28 x 40

Model	Pond Size Lts	UV Watts	RRP	Was	SALE PRICE
6000	6000	9	£259.99	£429.99	£99.99
8000	8000	9	£319.99	£459.99	£129.99
12000	12000	18	£399.99	£499.99	£169.99

Value Sets! Special Offer 'B' Sets include Hose & Clips
25mm hose (5m) & 25mm Hose Clips (pair)

Add a pump & save £££'s

Set Name	Suggested Pump	SALE PRICE	Save
FiltoBox 6000 Set	UltraFlow 3000	£139.99	£49.99
FiltoBox 8000 Set	UltraFlow 3600	£169.99	£59.99
FiltoBox 12000 Set	UltraFlow 6000	£229.99	£69.99
FiltoBox 6000 Set B	MightyMite 2000	£139.99	£33.47
FiltoBox 8000 Set B	MightyMite 2500	£159.99	£48.47
FiltoBox 12000 Set B	PondForce 6200	£199.99	£58.47

FiltoBox 8000

A new addition to the FiltoBox series this filter shares all the popular aspects of the 6/12000 plus additional features:

- Thermometer on lid
- Jap matt filtration level
- Maintenance indicator
- Outlet extension 50mm elbow

Elbow outlet extends filter positioning opportunities



Filters Outlets

Pipe through which clean water returns to pond from filter.

Model	Outlet size (diameter)	Extension Included?
6000	50mm	Yes (straight)
8000	50mm	Yes (elbow)
12000	70mm	No (pg113)



Pressurised Filters

PondXpert EasyFilter

These new filters are a joy to use - simply rock the switch to the 'clean' position to backflush the filter of accumulated dirt via the special waste outlet. This dirty water can be directed to your drain or flowerbeds.

- Easy clean feature
- In-built UVC for clear water
- Gradiated foams for mechanical filtration
- Biomeida for biological filtration
- Filter can be buried underground if required.



So easy to clean... 'Rocker' handle switches from 'clean' to 'waste'.



Three inlet/outlets as found on more expensive filters. 20-40mm Inlet, Outlet & Waste (12-25mm 4500)



PondHero Turn2Clean Filters

Introduced in 2025 these extra large pressure filters boast powerful UVCs & easy-clean technology. Their large capacity mean that pondkeeper's with bigger ponds can now enjoy the benefits of pressurised filtration.

The bigger filters come complete with increased features but still at a highly competitive price.

Dimensions (cm) 4500 - 27 x 37, 9000 - 34 x 44, 12000 - 34 x 52, 15000 - 55 x 53, 20000 - 55 x 63 diameter x height



Better landscaping - Can bury up to lid



Add a pump & save £££'s

Model	Pond Size Lts	UV Watts	RRP	OUR PRICE
EasyFilter 4500	4500	7	£199.99	£99.99
EasyFilter 9000	9000	9	£279.99	£139.99
EasyFilter 12000	12000	11	£339.99	£169.99
Turn2Clean 15000	15000	18	£399.99	£199.99
Turn2Clean 20000	20000	24	£499.99	£249.99

Set Name	Pump in Kit	OUR PRICE	Save
EasyFilter Set 1	UltraFlow 3000	£134.99	£54.99
EasyFilter Set 2	UltraFlow 6000	£179.99	£89.99
EasyFilter Set 3	UltraFlow 8000	£224.99	£94.99
T2C 15000 Set	UltraFlow 10000	£239.99	£69.99
T2C 20000 Set	UltraFlow 12000	£279.99	£79.99

Pressurised Filters



Hozelock Bioforce was the original pressure filter. In 2015 the Bioforce Revolution launched. This revamped design completely re-engineered pond filters for the 21st Century - and our customers love it!

This clever product features a **unique and innovative** cleaning mechanism. The secret to the success of this filter is its use of micro block foam filter media rather than the usual 'rings' or 'blocks'. This means the foams shed dirt and debris far more effectively.

- Powerful UVCs prevent green water
- Efficient Biological Filtration (Kaldness K3 media in bottom chamber)
- Diverter valve switches dirty unwanted water to waste outlet
- Hose Inlets 25-40mm.

Dimensions: 6000: 27 x 27 x 37cm (LWH), 9000: 27 x 27 x 46cm (LWH), 14000: 40 x 40 x 51cm (LWH),



The perfect filter upgrade
The Recommended pressure filter for koi/mixed fisheries.

Add a pump & save £££'s Exclusive Value Kits

Set Name	Pump in Kit	OUR PRICE	Save
Bioforce Value 6000	UltraFlow 5300	£369.99	£49.99
Bioforce Value 9000	UltraFlow 6000	£399.99	£79.99
Bioforce Value 14000	UltraFlow 8000	£499.99	£99.99



Model	Gold fish	Koi	UV Watts	RRP	OUR PRICE
Bioforce 6000	9000	6000	18	£489.99	£329.99
Bioforce 9000	13500	9000	24	£571.99	£369.99
Bioforce 14000	21000	14000	36	£706.99	£449.99

Set Name	Pump in Kit	OUR PRICE	Save
Bioforce 6000 Kit	Aquaforce 4000	£469.99	£27.99
Bioforce 9000 Kit	Aquaforce 6000	£549.99	£39.99
Bioforce 14000 Kit	Aquaforce 8000	£639.99	£59.99

Pressurised Filters

SpinClean Filters

pondXpert



SpinClean 20000
Free W Boost
Was 18w now 24w

SpinClean 12000
Free W Boost
Was 11w now 13w

4500/6000 20/25/32mm **20000** 20/25/32/40mm
8000 12/20/25mm **30000** 25/40/50mm
12000 20/25/32/40mm **40000** 32/40/50mm

Add a pump & save £££'s

Model	Pond Size Ltrs	UV Watts	RRP	OUR PRICE	Set Name	Pump in Kit	OUR PRICE	Save
SpinClean 4500	4500	11	£279.99	£139.99	4500 Set	UltraFlow 3000	£179.99	£49.99
SpinClean 6000	6000	13	£339.99	£169.99	6000 Set	UltraFlow 3600	£219.99	£49.99
SpinClean 8000	8000	13	£399.99	£199.99	8000 Set	UltraFlow 5300	£249.99	£69.99
SpinClean 12000	12000	13	£479.99	£239.99	12000 Set	UltraFlow 8000	£299.99	£89.99
SpinClean 20000	20000	24	£599.99	£299.99	20000 Set	UltraFlow 12000	£349.99	£129.99
SpinClean 30000	30000	36	£839.99	£419.99	30000 Set	UltraFlow 14000	£459.99	£149.99
SpinClean 40000	40000	55	£999.99	£499.99	40000 Set	UltraFlow 16000	£529.99	£169.99

Just look at our test results . . .



Fig. 1



Fig. 2



Fig. 3

We were astonished (and embarrassed!) by the amount of dirt the filter picked up. **Fig. 1** shows the discharge with **Fig. 2** showing the dirt continuing to flow. By **Fig. 3** we were ready to switch the water back to the pond. After completing this very easy cleaning regime a few times in a fortnight the positive results were clearly visible.



pondXpert

SpinClean Auto Filters

Procedure when it's time to clean:

- 1) Switch Off Pump.
- 2) Turn blue dial so arrow is facing waste outlet.
- 3) UV light turns colour red and the motor turns the cleaning paddle against the sponges.
- 4) After 3 minutes cleaning a beep indicates cleaning is finished.
- 5) Switch pump on to wash dirt away to waste.



Procedure Update - Users report that pump doesn't have to be turned off during cleaning. Turn blue dial on/off to clean!

Add a pump & save £££'s

Model	Pond Size Ltrs	UV Watts	RRP	OUR PRICE	Set Name	Pump in Kit	OUR PRICE	Save
SpinClean+ 4500	4500	11	£339.99	£169.99	4500+ Set	UltraFlow 3000	£199.99	£59.99
SpinClean+ 6000	6000	13	£399.99	£199.99	6000+ Set	UltraFlow 3600	£239.99	£59.99
SpinClean+ 8000	8000	13	£499.99	£249.99	8000+ Set	UltraFlow 5300	£279.99	£89.99
SpinClean+ 12000	12000	13	£599.99	£299.99	12000+ Set	UltraFlow 8000	£339.99	£109.99
SpinClean+ 20000	20000	24	£739.99	£369.99	20000+ Set	UltraFlow 12000	£429.99	£119.99
SpinClean+ 30000	30000	36	£999.99	£499.99	30000+ Set	UltraFlow 14000	£569.99	£119.99
SpinClean+ 40000	40000	55	£1259.99	£629.99	40000+ Set	UltraFlow 16000	£699.99	£129.99
SpinClean+ 50000	50000	55	£1699.99	£849.99	50000+ Set	UltraFlow 16000	£919.99	£129.99
SpinClean+ 75000	75000	60	£1999.99	£999.99	75000+ Set	UltraFlow 20000	£1099.99	£129.99



New Bigger AUTO for KOI Ponds and Ponds up to 75,000 Ltrs [See Pg 63](#)

Large choice of model sizes
A perfect filter for every pond!

SpinClean Filter Caps (Standard and Auto)

Bespoke design to help your filter blend into your water garden surrounds.

Two types. Two finishes. Highly realistic sandstone and slate/grey finish.

Medium

(models 4500-20000) 62x66x23cm LWH
Was £139.99 **NOW £97.99**

Large

(models 30-75000) 73x62x23cm LWH
Was £179.99 **NOW £125.99**

Large Tree Stump Design

(mods 30-75000) Was £179.99 **NOW £125.99**



Cap (sandstone) showing filter in position.

Koi Filters

Evolution Aqua EazyPod

Evolution Aqua produce the most modern pond filters on the market today. The EazyPod has been designed with small koi ponds in mind (10,000 litres - 2200 gallons) but it's superior design can also be employed on ornamental/goldfish ponds. In this less demanding environment the EazyPod can handle up to 20,000 Litres (4400 gallons)

How it works . . . Regular Running

Dirty water enters filter and is drawn to the centre of the pod. Water passes through special Kaldness filter media which traps the dirt. Dirt gets stuck in the filter media - clean water returns to pond.

How it works . . . Cleaning

Switch off pond pump. Switch on air pump to agitate the filter media. Filter media bubbles up and dirt is dislodged. Run dirt to waste - Switch pump back on.

23inches (58cm) tall and wide

New Colour Choice
All EazyPods now available in green colour finish too!



EazyPod Complete

Model	RRP	OUR PRICE
EazyPod	£564.95	£499.95
EazyPod Air	£729.95	£649.95
EazyPod Air 18w UV	£789.95	£699.95

New Auto EazyPods	
Model	OUR PRICE
EazyPod Automatic Air	£789.95
EazyPod UV Automatic	£849.95

Air versions come complete with a 70lph air pump and fittings worth **£179.95** Available in Grey or Green colour finish.

Nexus 220 & 320 Koi Filters

For larger koi ponds the Nexus Eazy 220 and 320 are proving highly popular with our customers. The concept of the vortex shape with the EazyPod is repeated but the air pump also supplies an outer chamber. This 'floating bed' is full of media and is rich in healthy bacteria to convert Ammonia and Nitrite into harmless Nitrate. The 220 can be used with koi ponds up to 18000 Ltrs (4000 gallons), the larger 320 up to 34000 Ltrs (7500 Gallons)

Dimensions (LxWxH)

210: 126 x 111 x 85cm **310:** 143 x 132 x 103cm

Model	OUR PRICE	Save
Nexus 220	£1,445.00	-
Nexus 320	£1,645.00	-
Nexus 220 & 95lpm Air Pump	£1,599.99	£154.96
Nexus 320 & 130lpm Air Pump	£1,899.99	£134.96



Astonishingly small footprint for such an effective filter

Nexus Auto-Kits

Automates cleaning

Gravity Fed Auto Kit £674.95
Pump Fed Auto Kit £579.95

Koi Filters



X2 Floating Biomedia 25L RRP £79.99
16mm dia. x 10mm Effectively generates healthy bacteria. **Our Price £39.99**



Pro 50
60x60x81cm

Pro 75
75x75x88cm

SpinClean AUTO Pro 50 & 75

The first pressure filter designed with Koi-Keeping in mind. Perfect for keeping water clear & healthy in large ponds up to 75,000 Litres (Koi ponds 37,500 Litres). Supplied with X2 Biomedia, a cassette of larger Biomedia & filter foams.

						Add a pump & save £££'s			
Model	Pond Size Ltrs	UVC	X2 Media	RRP	OUR PRICE	Set Name	Pump in Kit	OUR PRICE	Save
Pro 50	50000	55W	35L	£1699.99	£849.99	Pro 50 Set	UltraFlow 16k	£919.99	£129.99
Pro 75	75000	60W	70L	£1999.99	£999.99	Pro75 Set	UltraFlow 20k	£1099.99	£129.99

Both filters accept hose sized 25/40/50mm. 'One Touch' motorised cleaning is activated by twisting blue Control Dial on lid of unit. Chamber capacity of new 75 model is a massive 300 ltrs and pallet delivery is included.



Hand crafted extra large fibreglass chamber (volume 170 Ltrs). 226% bigger than the 40000.



Cut-away image shows internal foams and Floating Bed. Floating Bed creates a home for healthy bacteria.



Solid particles from dirty water attach to foams. Water flow then forces biomedia to tumble around the extensive outer skin area.

PondXpert MultiChamber Pond Filters

Professional multi-bay filters at a highly reasonable price. There is a good range of sizes with a solution to most pond requirements. Each filter box/bay comes complete with graduated foams, filter mat and biomedia. The foams sit in cassettes and are very easy to remove - simply push the sponges against the grips for easy cleaning.

"GreenStop Pro" UVC Upgrade

– Enhanced UVC Unit which fits neatly onto the rear of all models as shown (attached to MultiChamber 18000).

- 2 x Inlet Hosetails 20-40mm
- Temperature Dial in lid
- 2 x Outlet pipes. One 70mm and one stepped fits 40/50mm
- Foams, Japanese matting and biomedia included

Dimensions (LxWxH) 9000 - 535 x 465 x 405
18000 - 900 x 540 x 405 36000 - 1335 x 540 x 405

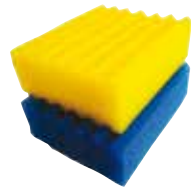

Replacement Foams (4 set)

Coarse/Blue £29.99
Fine/Yellow £29.99



Replacement Jap Matt (single)

One Size Only £19.99

MultiChamber Cleaning Tool

Cleans foam without removing them from filter. £19.99



Maximum Choice – Three Great Models - Twelve ways to Buy! 3 different box sizes, with or without UVC, add a pump or buy the lot! Build up the filter system that is just right for your pond - *the more you buy the more you save!*



Half Price – PondXpert UltraFlow Filter Pumps.

Half Price – 36w PRO UV Usually £149.99 **Only £74.99** with any Multichamber Filter.

Model	Pond Size Lts	RRP	OUR PRICE	Add ½ price 36w UVC	Filter plus Pump	OUR PRICE	Filter plus Pump & UVC	Save
MultiChamber 9000	9000	£259.99	£129.99	£204.98	UltraFlow 6000	£194.99	£299.99	£109.98
MultiChamber 18000	18000	£459.99	£229.99	£304.98	UltraFlow 10000	£314.99	£419.99	£129.98
MultiChamber 36000	36000	£679.99	£339.99	£414.98	UltraFlow 16000	£439.99	£529.99	£159.98

Outdoor Power Management

The use of weatherproof outdoor switchboxes mean you just need one cable to your mains supply and you can control your equipment pondside. Any lengths of exposed outdoor cable should be housed in a metal sheath to prevent accidental breakage.

PondXpert Outdoor Switchboxes

Outdoor switchboxes are essential pondkeeping kit. These sturdy switchboxes offer a number of outlet options and are easy to wire up.

Max load per outlet 400 watts.

Max load per 'box (1200W/1600W/2400W for 3/4/6 Way respectively). Inlet accepts standard outdoor cable.

3-way RRP £69.99 Was £34.99 **Sale Price £29.99**

4-way RRP £79.99 Was £39.99 **Sale Price £34.99**

6-way RRP £109.99 Was £54.99 **Sale Price £44.99**

3-way for Armoured RRP £109.99 **Our Price £54.99**



IMPROVED

larger terminal blocks for easier wiring and 3 year guarantee.



Powersafe Switch Box

Allows connection of up to 5 electrical cables from one standard mains cable. Easy installation and outlet is individually fused - if one blows the others continue. Max load is 1000w for first outlet and 300w for remainder.

2 Way RRP £56.49 **Our Price £41.99**

3 Way RRP £67.99 **Our Price £49.99**

4 Way RRP £88.99 **Our Price £64.99**

5 Way RRP £112.99 **Our Price £79.99**



Power Breaker RCD

Added safety. Designed specifically for water gardening. Great for pond vacuums.

RRP £19.99 **Our Price £14.99**

PondXpert Electrical Cable Connector

Joins electrical cable with a watertight seal but has the benefit of being able to 'snap off' the connection.

This means that outdoor items such as pond pumps can be easily disconnected and removed when necessary (eg, winter).

No cap is available on this new model.

RRP £39.99 **Our Price £19.99**



PondXpert Electrical Cable Joiner

Waterproof connector - perfect for extending power cable length.

1 Joiner 3 Way RRP £29.99 **Our Price £14.99**

2 Joiner RRP £25.99 **Our Price £12.99**



Armoured Cable

£4.00 per metre

Outdoor Cable

£1.50 per metre

Pond Cleaning Tools



These nets are strong enough to fish a pump out of the water

PondXpert VariNet HD - Interchangeable Head Hand Net System

Extra Strong Nets - Ideal for handling big jobs around the pond

Super strong pond net with hyper-extension telescopic pole. This professional net system has a choice of heads. Max reach 3m (10') Rubberised finish and scrape bar protection on netting for long life Pole is lightweight (yet incredibly strong) - so more comfortable in use.



Image shows standard VariNet pole vs VariNet HD pole. The difference in girth is easily evident plus the HD poles come with a foam grip half way down the shaft for better grip.

Alongside the original 3m length telescopic pole there are new fixed length 1m and 0.4m poles.



VariNet HD 'Essentials' Deal

- 3m Telescopic Pole
- + Sludge Head
- + Skimmer Head
- + Catch Net Head

Deal Price £69.99 Save £25.97



Skimmer Net



Catch Net



Sludge Net



Model	3m Pole + Head Save £9.99		
	RRP	OUR PRICE	DEAL PRICE
Catching Net 41cm x 46cm x 30cm LWD Large mesh	£45.99	£22.99	£39.99
Sludge Net 41cm x 46cm x 20cm LWD Medium mesh	£45.99	£22.99	£39.99
Skimmer Net 53cm x 25cm x 10cm LWD Fine mesh	£45.99	£22.99	£39.99
Koi Sock (Waterproof OR permeable)	£45.99	£22.99	£39.99
Koi Pan Small 60cm diameter, Fine mesh	£59.99	£29.99	£46.99
Koi Pan Large 75cm diameter, Fine mesh	£69.99	£34.99	£51.99
HD Telescopic Pole 3m (10')	£53.99	£26.99	
HD Fixed Length Pole 40cm	£25.99	£12.99	
HD Fixed Length Pole 100cm	£35.99	£17.99	

Koi Socks

90cm long waterproof material plus 29cm long mesh part at the end. Flexible end part means it can be twisted round the wrist to cut off water flow when pinched.

Also available Net only version. Reduces lifting weight.

Koi Pan Nets

Japanese style pan net heads provide a wide shallow surface - nice and safe when netting your fish. Two sizes.



PondXpert VariNet - Interchangeable Head Hand Net System

The right net for every job!

6 different heads and a choice of 3 different length poles/handles.

Every pond is different! Choose the pond net right for you and add additional net-heads as you need them.

Note: VariNet & VariNet HD are different systems. Poles/heads can not be mixed between systems.



Pentagon 30cm

Pentagon 40cm

Algae Net

Sludge Net

Blanket Weed Brush



Model	1.8m Pole + Head Save £5.99		
	RRP	OUR PRICE	DEAL PRICE
Pentagon Fish Net Head 30cm (30cm deep) Large mesh	£19.99	£9.99	£16.99
Algae Net Head 40cm (5cm deep) Very fine mesh	£19.99	£9.99	£16.99
Sludge Net Head 40cm (18cm deep) Medium mesh	£25.99	£12.99	£19.99
Pentagon Fish Net Head 40cm (30cm deep) Large mesh	£25.99	£12.99	£19.99
Blanket Weed Brush Net Head Tough brush	£17.99	£8.99	£15.99
Light 'n' Easy Skimmer Head Very fine mesh	£25.99	£12.99	£19.99
Standard Skimmer Very fine mesh	£19.99	£9.99	£16.99
Fixed Handle 1.2m (4')	£15.99	£7.99	
Telescopic pole 1.5m (5')	£19.99	£9.99	
Telescopic pole 1.8m (6')	£25.99	£12.99	

VariNet 'Essentials' Deal

- 1.8m Telescopic Pole
- + Sludge Head
- + Skimmer Head
- + Catch Net Head

Deal Price £29.99 Save £15.97

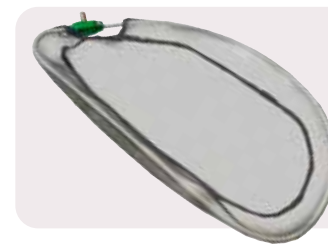

6 Light 'n' Easy Skimmer

Premium Skimmer Head affixes at 45° meaning debris can be scooped with a 'golf club' style approach.



7 Standard Skimmer

Flat net with fine mesh. Handy for picking up small debris from pond surface

Choice of three handle/pole lengths



Pond Cleaning Tools

PondXpert Skimmster

Bargain skimmer ideal for small ponds up to 25 square metres (16x16ft) surface area.

- 45 watts
- 2500lph integrated pump
- 10m power cable

RRP £139.99 Was £69.99
Sale Price £49.99



Velda Duo - Pond Scissors & Grabber

Clever six foot long (180cm) tool to prune pond landscape and pick up debris.

RRP £59.99 **Our Price £49.99**



PondXpert Collapsible Pond Nets

Quality nets - essential pieces of pondkeeping kit. The telescopic collapsible nets are perfect for landing fishing, hooking objects out of the pond and skimming off debris. Extra-Long Reach (max Length 2.2m).

- 1 Pondxpert Collapsible Skimmer Net RRP £39.99 **Our Price £19.99**
- 2 Pondxpert Collapsible Landing Net RRP £39.99 **Our Price £19.99**



PondXpert Pond Maintenance Set

Kit includes a sturdy telescopic aluminium pole and three interchangeable heads. The pole extends up to 1.8m (6') yet the whole kit fits into a small box for easy storage/transportation. The tools simply screw onto the end of the pole and include:

- 40cm/ 16" catching net
- 35cm/ 14" round skimming net
- Sturdy pond brush to keep waterfalls and pond edge clean

RRP £69.99 Was £34.99 **Sale Price £29.99**



PondXpert Pond Shelter

This new and innovative pyramid net keeps leaves, debris and predators out of your pond.

The frame's telescoping design allows it to be placed on uneven ground. The mesh netting comes already pre-assembled on the frame, meaning that no assembly is required. Includes 30 ground stakes.

- Great for ponds up to 3.5m x 6m
- Protects without disturbing plants

Sale Price £119.99 SAVE £10



Pond Liner Brush

This stiff adjustable brush with quality alloy handle is ideal for brushing off any algae that may collect on the exposed sides of your pond liner.

Length 1.7m.

RRP £44.99
Our Price £39.99



PondXpert Pond Gloves

New improved shoulder length pond gloves.

Extra-long gauntlet offers top protection.

One size fits all.

Was £19.99
Sale Price £14.99



Hozelock Pond Grabber

Handy cleaning tool for grabbing items that have fallen out of reach into your pond.

- Simple trigger (with lock) mechanism
- Magnetic! Can Retrieve light metal items
- Twist and lock feature which allows the grabber head to be used vertically or horizontally
- Total length of 90cm
- Rubberised grabber pads, protects liner from harm
- Rubber comfort grip

RRP £27.49 **Our Price £24.99**



Hozelock BlanketWeed Brush

Super value cleaning tool. The Hozelock Telescopic Blanket Weed Brush is a very simple and effective way to manually remove unsightly blanket weed from the pond. It has a durable nylon brush head and high quality telescopic handle which extends from 0.6m (2ft) to 1.8m. (6ft).

RRP £30.99 **Our Price £27.99**



Pond Netting

PondXpert Pond Cover Net

Hard-wearing nets designed to cover the pond surface and protect from fallen leaves and other debris. Also protects fish from predators. Packs include pegs for secure installation.

Mesh size 12mm(1/2").

- 3 x 2m RRP £15.99 **Our price £7.99**
- 4 x 3m RRP £29.99 **Our price £14.99**
- 6 x 4m RRP £45.99 **Our price £22.99**
- 10 x 6m RRP £73.99 **Our price £36.99**



Velda Premium Cover Net

Buy Once - Use Again & Again & . . .

Premium pond cover net - the best we have seen!

This finely-woven and durable cover net is very effective in keeping leaves and debris out of your pond in the autumn and will keep herons and other intruders at bay all through the year.

- Premium Net 3 x 2m RRP £19.99 **Our price £16.99**
- Premium Net 4 x 3m RRP £31.79 **Our price £24.99**
- Premium Net 6 x 5m RRP £57.69 **Our price £49.99**
- Premium Net 10x 6m RRP £99.99 **Our price £79.99**

3 x 2m, 10 pegs, 4 x 3m, 14 pegs
6 x 5m, 22 pegs, 10x 6m, 32 pegs



Very finely woven - 1cm square mesh catches small debris.



Reinforced edge all around Strong holding rings



Strong metal pegs keep net in position



Zip bag for storage

Blagdon Pond Cover Nets

Fine black mesh nets designed to be pitched across pond surface to prevent debris such as falling leaves dropping into pond. Can also be used to deter predators such as herons.

Nets come with fixing pegs supplied.

Size	RRP	OUR PRICE
3x2m	£12.99	£10.99
4x3m	£22.49	£18.99
6x3m	£30.99	£25.99
6x4m	£38.49	£31.49
6x5m	£44.99	£37.49
10x6m	£72.99	£59.99



PondXpert Swap Net Set

Keep your pond in tip-top condition with this pond maintenance set.

Set contains:

- A sturdy telescopic pole extends to 6 feet (1.8m)
- 30cm Skimmer Net head for skimming out fine debris and waste off the pond surface
- Tough Brush Head for scrubbing waterfalls and liner sides. Handy for lifting out blanket weed using a 'twirling' action too

Was £29.99 **Now £19.99**

Pole fits onto VariNet net heads. See pg 67.



Pond Vacuums - Manual/Water Pressure Pond Vacuums

PondXpert Telescopic Pond Silt Remover

Hand Operated

A simple, easy to use hand operated pump device for removing silt from the bottom of the pond.

Every pond accumulates a layer of silt and debris in the bottom of their pond no matter how hard you try to keep it clear. This can lead to problems with water clarity, pollution of the water etc and therefore should be removed frequently.

This silt vac is the ideal solution - lightweight and not powered by electricity, it can be taken to the pond, used to hand pump out the silt and stored ready for next use.

Every pond keeper should have one!

Features:

- Easy to use
- Telescopic - extends to 2 metres (6' 7")
- Also removes floating debris
- Complete with strainer bag
- Simple 'bicycle pump' action

Silt Remover

RRP £99.99 Was £49.99 **Now £39.99**



Pond Vacuums

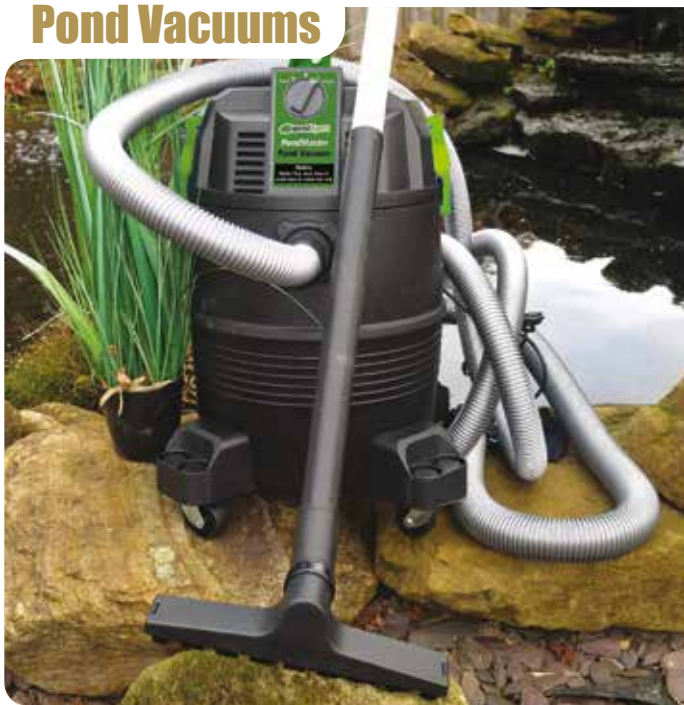

PondXpert PondMaster

We're delighted to be able to offer to you the best value pond vac we have ever seen.

Despite the low price this vac offers better features than all other budget pond vacuums on the market.

- Use Indoor or Out
- Extra Powerful 1400 Watts
- Large 35 Litre Chamber
- Auto-Empty when full
- Max. Operating Depth 2m
- 2 Year Guarantee
- Four Swivel Wheels
- Three Head Nozzels

RRP £239.99

Our Price £119.99

Add a Discharge Basket for **£20**

Combo Deal £139.99



PondXpert Pond Vac Discharge Basket

This handy filtration unit extracts solid particles from vacuumed pond water allowing clean water to return to the pond.

- Collapsible for easy storage
- Designed for use with pondmaster but can be used with all vacs

Discharge Basket RRP £89.99 **£44.99**

Basket Outlet Extension Hose 1m RRP £49.99 **£24.99**

PondXpert Pondmaster Vac + Basket **£139.99** Save **£24.99**



"Chamber" Style - Pond Vacuum Accessories

Discharge Collection Bag

Fine mesh discharge collection bag with locking mechanism for a tight fit.

Our Price £4.99



Replacement sponge Collar

Chamber vacs (Oase, Cleanopond & PondMaster) require the use of a sponge 'collar' to protect from particles.

Our Price £9.99



Pond Vac Indoor Bags

Replacement paper bags. Suitable for Cleanopond, Pondovac Start/Classic & PondMaster Vacs.

Pack of three £5.99

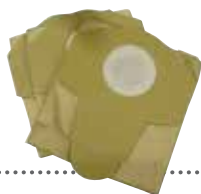

All vacs come complete with a choice of 3 head tools

Clean your pond like a pro with a Non-Stop Pond Vac. Integrated discharge pump allows continuous operation reducing time needed to clean a pond & also allowing dirty water to be pushed uphill.



Non-Stop Vac Classic

Vac with Integrated 11500lph, 4mm solids-handling pump cuts down cleaning time and allows dirty water to be pumped uphill.

2 year guarantee.

RRP £499.99 Was £249.99

Sale Price £199.99

Non-Stop 2

Same features as original but model upgrades include:

- Upgraded pump with 35mm solids-handling
- 12000lph Pump
- 3 year guarantee

RRP £599.99 Was £299.99

Sale Price £229.99

Common Specification (all 3 versions)

- Large 35 litre capacity
- Quality steel chamber
- 1200W Suction motor
- 4m suction hose
- 4 x suction extension pieces (2 clear)
- Discharge pump
- Choice of head tools
- 4m power cable
- 2m discharge hose
- Internal discharge bag (leaves/large particles)
- External discharge bag (fine particles)
- 4 x wheels



PondXpert Non-Stop 3 Pond Vacuum

Improved manoeuvrability and new distinctive design

- Push-bar with comfort grip
- Heavy duty wheels with extra pipe storage
- Attractive lime green coloured decals
- Three year guarantee

RRP £599.99 **Our Price £249.99**

Non-Stop Waste Extension Hose

5m length

RRP £59.99

Our Price £29.99



Fits all Non-Stop Vacs

Pond Vacuums

SludgeMuncher Pond Vacuum

A lightweight vacuum that is easy to manoeuvre. Whisper quiet compared to other vacs and only 80watts to run.

- 3m waste hose
- Extendable handle up to 2m (6'6")
- Easy 'in-pond' visibility

RRP £199.99 Was £99.99
Sale Price £79.99



SludgeMuncher Dirt Basket

Collapsible basket can be used to collect dirt & debris. (note: must be positioned lower than vac to work).

RRP £89.99 **Our Price £44.99**



Vac Wheel Set

"Wheely" Good Upgrade

A set of 4 wheels can be purchased to make for easier manoeuvring.

RRP £49.99 **Our Price £24.99**



Hozelock Pond Vacuum

A lightweight vacuum that is easy to manoeuvre. Whisper quiet compared to other vacs and only 80watts to run.

- 3m waste hose
- Extendable handle up to 2m (6'6")
- Easy 'in-pond' visibility

RRP £277.99 **Our Price £169.99**



Hozelock Waste Basket

Catch the dirt from your Hozelock Vacuum with this collection basket. Can be used pondside so cleansed pond water can be returned to your pond.

RRP £69.99 **Our Price £64.99**



Hozelock Vac & Basket Offer

Our Price £189.99 Save £24.99

*Free Basket is PondXpert brand

Pond Ultraviolet Clarifiers (UVCs)

Ultra Violet Clarifier

What is an Ultra Violet Clarifier?

A UVC consists of a chamber holding an electrical lamp behind quartz glass. Water is pumped through this chamber to prevent pond water turning green.

How Does It Work?

Pond water is subjected to high levels of U.V light. This U.V. light causes the microscopic single cell algae to be clumped together allowing them to be collected and broken down by the biological filter.

Before UVC

Typical "pea soup" colour.



After UVC

Clear water lets you see what is happening below the waterline.



PondXpert GreenClear UVC

Entry-level UVCs with small price but BIG features! Single inlet then choose to use single or dual outlet. 20/25/32/38/40mm Inlet/Outlet
 5m power cable

Model	Watts	Max Flow	Max Pond	RRP	OUR PRICE
GreenClear 7500	9	3000lph	7500L	£99.99	£49.99
GreenClear 9000	11	4700lph	9000L	£119.99	£59.99
GreenClear 15000	18	6200lph	15000L	£159.99	£79.99



PondXpert Greenstop UVC

Bestselling UVC from PondXpert. Comes complete with a set of hosetails to take 20/25/32/40mm hose. 1 year guarantee.



'Pro' model has 'turbulator' design to increase UV light exposure time. UV designed to fit snugly onto PondXpert MultiChamber filters



Model	Watts	Max Flow	Max Pond	RRP	OUR PRICE
Greenstop 9000	11	4500	9000	£139.99	£69.99
Greenstop 15000	18	7500	15000	£179.99	£89.99
Greenstop 23000	36	10000	23000	£219.99	£109.99
Greenstop 40000	55	20000	40000	£279.99	£139.99
Greenstop 36 Pro	36	10000	23000	£299.99	£149.99

Pond Ultraviolet Clarifiers (UVCs)

2yr Guarantee

Blagdon Pro UVC

High quality UVC with big ponds in mind - power outputs range from 18 watts to 72 watts.

Multi-hosetails (20-40mm) and solvent weld 1 1/2" pipework adaptors included.

- 2 year guarantee
- Power cable length 5m



Model	Watts	Max Flow	Max Pond	Sale Price	SAVE
Pro 16200	18	8100	16200	£121.49	£13.50
Pro 21600	24	10800	21600	£139.49	£15.50
Pro 32400	36	16200	32400	£146.69	£16.30
Pro 64800	72	32400	64800	£251.99	£28

Max pond figures are for a shaded, deep pond. A sunny / shallow pond will require extra power than quoted:

Sunny 25%
Under 75cm depth 25%
Koi 50%
8-10 watts per 1000 gall/ 4500 Ltrs.

Evolution Aqua Evo UVC



Quality compact UVC units.

- 15/25 58cm length
- 30/55 98cm length
- 75 128cm length
- 110 106cm length.

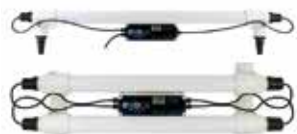

- IPX5 IP rating
- Can be used with flexible or hard pipe connections
- Ballast located in a fully water tight cover.
- Supplied with 2 x 38mm (1 1/2") hosetails

Model	Watts	Max Flow	Max Pond	RRP	OUR PRICE
evo15	15	7500	15000	£132.95	£127.95
evo25	25	10000	20000	£138.95	£133.95
evo30	30	15000	30000	£194.95	£184.95
evo55	55	20000	55000	£229.95	£204.95
evo75	75	25000	75000	£304.95	£284.95

Evolution Aqua Titanium UVC 55W & 110W

Premium clarifiers with titanium coated internal chambers.



99cm length.
Uses T8 55W bulbs.

Model	Watts	Max Flow	Max Pond	RRP	OUR PRICE
Titanium 55	55	20000	40000	£274.99	£259.95
Titanium 110	110	25000	50000	£379.99	£364.95

PondXpert SteriClear UVC

Quality UVC units with stainless steel chambers. Reflective properties of material boosts effectiveness by as much as 130% and also is better at eliminating bugs and pathogens.

NEW



36W UV - For ponds up to 40,000 litres (Dimensions: 55 x 25 x 7cm (LWH))



55W UV - For ponds up to 60,000 litres (Dimensions: 68 x 25 x 7cm (LWH))

Compact sizing (Uses shorter PLS style UVC bulbs). Choice of fittings for flexi-hose & rigid pipe included.

- Flexi-hose 38/40/50mm
- Rigid pipe (1.5" / 1.75" / 2")
- 1.0 bar max pressure
- 'UV working ok' indicator
- 5m power cable



Model	Watts	Max Flow	Max Pond	RRP	OUR PRICE
40000	36	16000	40000L	£299.99	£149.99
60000	55	20000	50000L	£399.99	£199.99

UVC Bulbs & Spares

UVC Quartz Sleeves

All UVC bulbs sit inside a watertight glass/quartz chamber that can get dirty over time. Quartz sleeves can be cleaned but we carry a comprehensive list of spares if required.

EasyClear 3000	£29.99	Vortron 55	£49.99	Bioforce R 9000	£39.99	EasyFilter 30000	£24.99
EasyClear 6000	£29.99	Greenstop 9000	£19.99	Bioforce R 14000	£49.99	Filtobox 6000	£19.99
EasyClear 9000	£34.99	Greenstop 15000	£19.99	SpinClean 6000	£19.99	Filtobox 12000	£24.99
TripleAction 3/4000	£19.99	Greenstop 23000	£24.99	EasyFilter 4500	£14.99		
Vortron 11	£35.99	Greenstop 40000	£24.99	EasyFilter 9000	£19.99		
Vortron 18	£39.99	Greenstop 36 Pro	£29.99	EasyFilter 12000	£24.99		
Vortron 36	£44.99	Bioforce R 6000	£34.99	EasyFilter 20000	£24.99		

Bulb	Bulb Type	OUR PRICE	Example Filter that Bulb fits
4W	Double ended - single tube	£8.99	Green Genie 2
5W	Single ended (Pls type)	£12.99	EasyClear 3 Bioforce 3
6W	Double ended - single tube	£9.99	G2C 3, Ecopower 2.5
7W	Single ended (Pls type)	£13.99	EasyFilter 4.5, Bermuda 4, Filtral 3
8W	Double ended - single tube	£11.99	G2C 6, TMC8, Ecopower 5, Green Genie 3
9W	Single ended (Pls type)	£14.99	EasyClear 6, Bioforce 5.5, Filtoclear 3, EasyFilter 9
11W	Single ended (Pls type)	£16.99	Bioforce 8, Filtoclear 6/11/15, Filtral 9, EasyFilter 12
13W	Single ended (Pls type)	£17.99	EasyClear 9000, Bioforce 12000 (mid 2012 on)
13W	Single ended (Pls type)	£17.99	GX Base Double Fin Bioforce 12 (pre-2012), Fishmate 15
15W	Single ended (Pls type)	£14.99	Fmate Gravity 15/30, TMC 15
16W	Double ended - single tube	£15.99	G2C 12, Ecopower 10, Green Genie 6 & 12
18W	Double ended - single tube	£17.99	G2C 18, Clear Pond 18
18W	Single ended (Pls type) 4 pin	£19.99	Filtomatic, Bitron 18, Midipond18, EasyFilter 20
24W	Single ended (Pls type) 4 pin	£24.99	Midipond14, Fmate 30, EasyFilter 24
25W	Double ended - single tube	£19.99	G2C 24/30/48, Clear Pond 25 & 50, Green Genie 24 & 48
30W	Double ended - single tube	£22.99	TMC30
36W	Single ended (Pls type) 4 pin	£27.99	Fmate 45, Bitron 36/72
40W	Double ended - single tube	£21.99	Clear Pond 80
55W	Double ended - single tube	£24.99	TMC55, Lotus 55 UVC
55W	Single ended (Pls type)	£29.99	Bitron 55/110
75W	Double ended - single tube	£29.99	Lotus 75 UVC
100W	Double ended - single tube	£32.99	Lotus 100 UVC
11W	Single ended 4 pins	£19.99	Laguna pressure-Flo 2.5/5
20W	Single ended 4 pins	£24.99	Laguna pressure-Flo 8
25W	Single ended 4 pinse	£29.99	Laguna pressure-Flo 12

UV radiation power decreases over time. Bulbs should be replaced annually - preferably in spring.

Buy One get one FREE

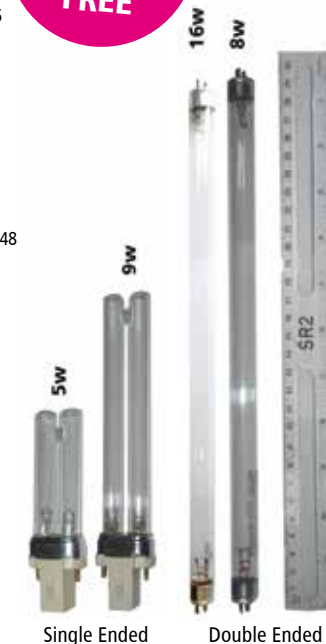

Air Pumps



Adding oxygen to a fishpond is very important to fish health. This is particularly true in summer months and if the pond is heavily stocked. But even in ponds without fish an air pump will help keep the water fresh - particularly if a waterfall or fountain is not present.

What Size of Pump for my pond?

We have included a table (right) as a buying guide. Many pondkeepers do not keep fish in the pond and here addition of a smaller air pump will be sufficient. Fish ponds require a larger amount of air, koi ponds especially. If keeping other 'oxygen hungry' species such as sturgeon then the flow suggested above should be amplified further. Indeed please treat this as advice as a guide only - every pond is different. Remember oxygen can be gained from pond plants, fountains and waterfalls too!

NOTE: Remember the higher the water temperature the less dissolved oxygen the water can hold.

Air Pump Sizing Guide			
Air LPH	Pond Volume (Litres)		
Output	No Fish	Fish	Koi
210	1500	1100	500
450	3000	2500	1200
600	4250	3300	1650
1200	8500	6600	3300
1800	12750	10000	5000
2400	17000	13200	6600
3600	25500	20000	10000
4800	34000	26400	13200
6000	43200	33000	16500

PondXpert ElectroAir Pond Air Pumps

We're proud to be able to bring to you these sturdy professional air-pumps at a highly competitive price. All pumps have been manufactured with a heavy metal outer casing to add ballast which reduces noise in operation.

Fully weatherproof with 2m (7 feet) power cable.

Model	Max Air Output	RRP	Watts	OUR PRICE	Price Inc. Air Kit
2100	2100 lph	£219.99	20	£109.99	£122.98
2700	2700 lph	£239.99	25	£119.99	£132.98
3600	3600 lph	£259.99	38	£129.99	£142.98
4800	4800 lph	£329.99	55	£164.99	£177.98
6000	6000 lph	£359.99	65	£179.99	£192.98



Half-Price Accessories Kit

Accessories Kit contains (A) a six-tap chrome manifold, (B) four large 50mm airstones and (C) 25 metres of 4mm clear airline.

Usual selling price £26.94 **Our Price £24.99**
Promotional Price Only £12.99 when purchased with any ElectroAir Pump

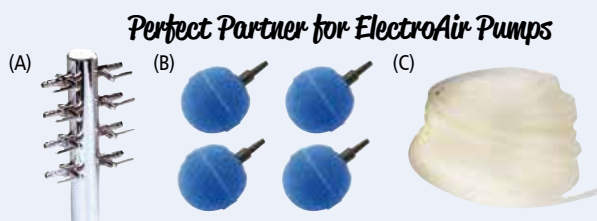

Perfect Partner for ElectroAir Pumps

Air Pumps

PondXpert ElectroAir Compact

Weatherproof air pumps designed for outdoor use. Durable pumps with polymer composite rubber air chamber held under aluminium casing.

- Quiet Operation
- Efficient Eco motor with low energy use
- Robust Design
- Includes all fittings to get you started
- Includes 2m (7') power cable.



210 & 450 Different Design
* 210 & 450 simple fittings only - see listing below



Pondkeeper Recommended product

Quality fittings including chrome manifold *

Model	Max Flow Rate (per hr)	Power	Air Stones	Air Tubes	Manifest	RRP	OUR PRICE
EA Compact 210	210	3.3 Watts	2	2x5m	N/A	£49.99	£24.99
EA Compact 450	450	6 Watts	2	2x5m	N/A	£69.99	£34.99
EA Compact 600	600	10 Watts	2	2x5m	2 - way	£119.99	£59.99
EA Compact 1200	1200	15 Watts	2	2x5m	2 - way	£149.99	£74.99
EA Compact 1800	1800	25 Watts	4	4x5m	4 - way	£179.99	£89.99
EA Compact 2400	2400	30 Watts	4	4x5m	4 - way	£219.99	£109.99
EA Compact 3600	3600	35 Watts	8	8x5m	8 - way	£279.99	£139.99

Hozelock Air Pump Range

Stylish, reliable weatherproof range of air pumps. There is a comprehensive range to suit most ponds. All are fully weatherproof so can be left outside. 3m long power cables with 320 & 640, 10m with others.



Model	Air Flow ltrs	Max Depth	Air Stones	Air Tube	Watts	Power Cable	RRP	OUR PRICE
Hozelock 320	320 per hr	1.2m	2	10m	4	3m	£77.79	£54.99
Hozelock 640	640 per hr	1.2m	4	10m	8	3m	£121.49	£89.99
Hozelock 1500	1500 per hr	2.0m	2	20m	17	10m	£206.99	£149.99
Hozelock 4500	4500 per hr	3.0m	2	20m	75	10m	£322.99	£229.99

ElectroAir Air Pump Accessories

All ElectroAir and ElectroAir Compact pumps come complete with 4mm outlets. We now stock a full range of accessories based on this 4mm fitting (This is the most popular size and these products will fit any other brands using the size of outlet).

- (A) ElectroAir 15cm Plate Air Stone **£9.99**
- (B) ElectroAir 13cm Heavy Air Stone **£2.99**
- (C) ElectroAir Chrome Manifold 6 way **£8.99**
- (D) ElectroAir Airline 4mm x 100m Clear **£29.99**
- (E) ElectroAir Clear 4mm Airline x 25m **£9.99**
- (F) ElectroAir 2"/50mm Air Stone Blue **£0.99**
- (G) ElectroAir 2"/50mm Air Stone Sintered Grey **£1.99**
- (H) ElectroAir 4mm Check Valve **£0.49**



EA Black Sinking Hose for maximum disguise. 4mm. **£2.99** per metre



PondXpert Black Sinking Airline 25m

Black weighted airline (4mm internal diameter). Makes for a tidier pond appearance for a super low price.

RRP £59.99 Was £29.99 **Sale Price £24.99**

PondXpert Clear Airline and new Weighted Black Airline running attached to the same air pump in one of our own ponds. **The difference is striking!**



Spring Sale



Sinking Airline does not show

Standard Airline can look unsightly



Black Airline is more discreet around the pondside.

Air Pumps

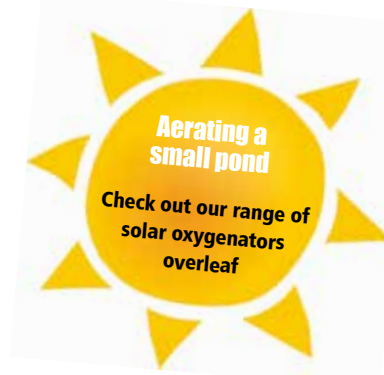

Blagdon Pond Oxygenator Kit

New outdoor weatherproof air pump kit.

	Small	Standard	Medium
Watts	3.2w	4.2w	8.3w
Max Flow	140lph	320 lph	640lph
Max Depth	1.2m	1.4m	1.6m
RRP	£35.95	£52.54	£85.09
Our Price	£29.99	£39.99	£67.99

Pumps supplied with 1.5m cable

Blagdon Pond Oxygenator

New pond air pumps replacing the previous 'Koi Air' air pumps sold by this brand. Each pump is supplied with a multi-outlet connection (1800 = 6 outlets, 2400 = 10 outlets, 3600 = 20 outlets).

Please note that no airline, airstone or tap valves are included with this item.

We recommend the PondXpert Accessories Kit or choose from air accessories opposite.



Air Accessories Kit **£24.99** (see pg78)

Model	Air Flow ltrs	Max Depth	Air Stones	Air Tube	Watts	Power Cable	RRP	OUR PRICE
Oxygenator 1800	1800lph	2.2m	0	0	16	5m	£99.62	£79.99
Oxygenator 2400	2400lph	2.8m	0	0	20	5m	£138.57	£99.99
Oxygenator 3600	3600lph	3.0m	0	0	32	5m	£164.86	£119.99

Solar Air Pumps

PondXpert SolarAir 100

Max Air Output 100lph, one airstone, 1m airline, 1W Panel.

RRP £69.99

Our Price £34.99



Solar Air Pumps BATTERY



Pond life needs oxygen more at night. Plants produce oxygen during the day then consume it at night risking potential air depletion especially in warm weather.



PondXpert SolarAir 200

Max Air Output 200lph, one airstone, 1m airline, 1.4W Panel.

RRP £89.99 **Our Price £44.99**



PondXpert SolarAir Float

Air pump designed to float on the surface of your pond (or can be moored pondsides).

- Maximum air Output 150lph
- 0.8W solar panel
- 0.5m airline with single airstone



RRP £79.99 **Our Price £39.99** Battery version **£49.99**



PondXpert SolarAir 150 PLUS

Solar air Pump with Lithium battery. Pump integrated into panel to save space. Max Air Output 80lph, one airstone, 1m airline. Quality Lithium battery. 4.5W solar panel.

RRP £99.99

Our Price £49.99



PondXpert SolarAir 200 PLUS

Solar air Pump with Nimh AA battery. Twin airstone. Battery can be charged by mains adaptor (available separately). Max Air Output 200lph, two airstones, 2m airline. 5.5W solar panel.

RRP £119.99

Our Price £59.99



Accessories

PondXpert SolarAir 200 PLUS Mains Adaptor Set

Use this new 6.3V mains adaptor to charge up the battery-pack supplied with the unit. Set includes an adaptor to fully charge the battery and a transformer cable so unit can be powered directly from the mains. Set is not weatherproof - charging must be indoors or a dry area. Enables air-pump to be used indoors (eg, for an aquarium).

RRP £25.99 **Our Price £12.99**

All adaptor & transformer cables **NOT** weatherproof



PondXpert Replacement Airstones

Airstones will wear out over time - don't worry as we have the replacement airstones suitable for all PondXpert models.

Round 20mm RRP £1.99 **Our Price £0.99**

Disc 40mm RRP £2.99 **Our Price £1.49**



Filibert Frog's Top Tip

Switch up your solar oxygenator standard airline to weighted 'sinking airline'. It disappears from water surface - making your pond much more attractive! See pg80

New Sinking Airline 10m length mini-roll **only £9.99**

PondXpert SoloOxy 200

High output lithium battery pumps with 3 model options. Able to run 24hrs per day. Two operating modes 'Continuous' & 'Interval cycle'. Flow control low/medium/high. Available with 1 or 2 outlets & a premium model with Remote Control.

- 5W panel
- Max output 200lph
- 3.7v-4000mAh Battery
- XL airstones
- USB charging (cable inc.)



NEW

SoloOxy 200 Single RRP £119.99 **Our Price £59.99**

SoloOxy 200 Duo RRP £139.99 **Our Price £69.99**

SoloOxy 200 DuoRC RRP £159.99 **Our Price £79.99**

In 'Day' mode the pump will output air when sun is shining with any surplus energy being stored into battery for use when weather conditions change. When 'Night' mode is selected the pump will store energy during the day then automatically oxygenate the pond at night (when your pond needs it most). Max. run time (on battery) 12hrs.

- Unique twin motor design
- Reliable proven performance now with higher power solar panel



Auto-start at dusk feature

Pond Deterrents

Isn't it time to scare away those pesky herons for good?



Velda Laser Guard

Hérons are one of the hardest creatures to scare away but Velda of Holland are determined to find the answer!

The latest motion-activated deterrent utilises laser lighting, strobe effect and three different degrees of sound.

Our Price £199.99



Pond Protector - Harmless electric fence

Efficient method to keep herons and cats away from a pond. The transformer gives off a low voltage electric pulse to the fence round the pond.

This shocks herons or cats and persuades them to try elsewhere. Inclusive of transformer, 10 synthetic rods, 80m of electric fence, connectors and instructions.

The electric cable has a length of 80m, which is sufficient to protect 40 metres of pond side with two cables. Extension set provides an additional 40m coverage.

Pond Electric Fence Was £99.99 **Now £69.99**

Pond Electric Fence Extension Set £39.99

Protector + Extension £89.99 **SAVE £19.99**



Velda Spinner

Spinning scarer moves in the wind.

RRP £38.99 **Our Price £29.99**



Velda Reflector

Floating mirrored sphere scarer.

RRP £26.99 **Our Price £19.99**



Replica Heron

Hérons are territorial creatures so usually avoid each other. Place this realistic replica near your pond and it should help to stop the real thing.

Was £24.99

Our Price £19.99



Near Invisible Protection

2 for 1 Offer £29.99
60 rings for the price of 30



PondXpert Pond Protectors Floating Fish Protection System

Bestselling 'floating grid' protection system.

Simply join the discs together to form a formidable barrier against unwanted herons.

Get 60 Rings for every 30 purchased with our special offer.

PondXpert Pond Protectors 30 (30 rings, 96 clips)

RRP £59.99 **Our Price £29.99**



Sizing Guide:
10 rings protects 5 feet (1.52m) of shoreline

Interlocking Floating Ring Set

Filter Media

Buy 1 Get 1 FREE

PondXpert Filter Start Gel

Microbe packed gel that helps to mature filters quickly. 1 Litre treats 15,000L

PondXpert Filter Start 1Ltr

RRP £39.99 **Our Price £19.99**

EA Filter Start 1 Ltr

RRP £22.95 **Our Price £21.45**



PondXpert Filter Media Bags

Mesh bag with drawstring that can be filled with your choice of filter media. Then filled bag can be placed in your filter chamber.

Small Media Bag (45x30cm)

RRP £15.99 **Our Price £7.99**

Large Media Bag (60x45cm) RRP £19.99 **Our Price £9.99**



PondXpert Zeolite 5 Ltrs

(Approx 8kg)

Reduce algae & ammonia issues. FREE Filter Mesh Bag included.

RRP £34.99 **Our Price £16.99**



Velda (VT) Media 5 Ltrs (treat 3000L)

VT Filtra Sub Filter Media

Coarse structure helps remove coarse dirt particles. Perfect for the first stage of the filtration process.

RRP £19.99 **Our Price £15.99**



VT Zeolite Filter Media

Zeolite is a natural stone which binds nitrates & phosphates. This helps keep ponds algae free. Also useful at reducing ammonia & nitrite issues.

RRP £27.50 **Our Price £22.99**



VT Lava Rock Filter Media

Very porous rock - a natural material with many coarse pores. Ideal for the intermediate stage of filtration.

RRP £18.49 **Our Price £14.99**



VT Carbon Filter Media

Activated carbon is highly effective at removing fine particles such as: fine dirt, aromatic substances & colourings. Use as a final stage of filtration.

RRP £33.29 **Our Price £24.99**



Pond Treatments - Inline Dechlorinators

In-Line Dechlorinators

As most fish-keepers know tap water is great for us humans but not so good for the fish we look after. Tap water contains chlorine and other impurities that are hazardous to fish.

It is therefore essential that these elements are removed from tap water before it is used to 'top-up' or fill a pond. An inline dechlorinator saves playing around with messy liquid treatments or waiting for chlorine to 'gas-off'.

Simply running tap water through one of these units ensures your water is pond-safe straight from the tap and one unit will be enough to decontaminate 200,000 litres of water - an amount that will take a typical Pondkeeper 2 years to get through.



Evolution Aqua Detox Dechlorinator

Hi-grade activated carbon removes chlorine, chloramine, bromine, malachite green, dyes, colours, humic acids, organics, proteins, antibiotics, hormones and ozone.

Improved in 2017 with high capacity carbon for optimum chlorine removal. Recommended flow rate: 4 litres per min.

The 12 inch high-grade activated carbon filter will treat up to 225,000 Litres / 49,493 U.K. Gallons.

The 30 inch high-grade activated carbon filter will treat up to 550,000 Litres / 122,083 U.K. Gallons. Maximum treatable water is based on incoming 0.5ppm chlorine.

12" Detox Dechlorinator In Line Filter Our Price £84.95

30" Detox Dechlorinator In Line Filter Our Price £124.95



PondXpert 10" In-Line Dechlorinator

New advanced dechlorination from PondXpert. This unit is packed with superior materials meaning increased capacity can be achieved from a unit with a smaller footprint. Contains a blend of Hi Grade carbon and Ceramet active ceramics. Ceramet ceramics are porous and have an extremely large surface area (500 times that of carbon) and have been used in Japan for many years to keep Koi ponds clear and the fish free of disease.

Premium 'Hi Grade' carbon is used as a drinking water treatment illustrating its trusted quality and effectiveness. Cartridge will treat up to 150,000 litres. Max recommended flow rate 9 litres per minute (the slower the flow rate - the more impurities are removed).

RRP £139.99 **Our Price £69.99**

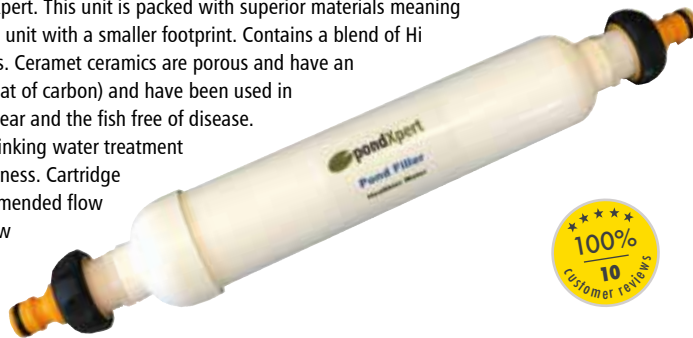

Pond Treatments - BlanketWeed Cures

Spring Sale



PondHero BlanketWeed Blaster - Solar Algae Remover

String algae or blanket weed can be a real problem in late spring/summer. This new solar ioniser from PondHero tackles the problem quickly and effectively.

Float the unit on your pond and sunlight activates release of copper ions into water. Copper ions bind themselves to pond contents preventing algae growth.

!!Excess copper ions are dangerous to pond life (see 'operating advice' below)!!

Benefits

- So easy! Simply floats on your pond surface
- Clears string algae quickly
- Releases copper ions to combat algae growth
- Works in sunny weather just when algae worst
- No messy wiring or running costs
- No need to cut into existing hose pipework

Save £30

Operating Advice

Not recommended for use in ponds with fish (can be used with careful monitoring). Use when pond water 12 degrees C or higher. Powerful & Effective - designed to be used for 'short blasts' in smaller ponds. Remove from action once weed is cleared.

Spares Kit

RRP £79.99

Our Price

£39.99



Anode depletes during use. But process is slow and anode should last multiple seasons

Replacement Copper Anode

RRP £49.99

Our Price

£24.99



Hanna HI-747 Copper Checker

Ultra-fine digital tester. Recommended if Blaster used in fish ponds.

HC: 0 to 999 ppb, plus 6 tests

RRP £97.20 **Our Price £89.99**



Specification

- Suitable for ponds up to 35,000 Litres volume
- Set contains Blaster unit, test strips & brush
- 2W Solar Power (6v)
- Also suitable for hot tubs and swimming pools

PondHero BlanketWeed Blaster - Solar Ioniser

RRP £159.99 Was £79.99 **Sale Price £49.99**



Pond Treatments - BlanketWeed Cures



BlanketWeed is a long string algae that thrives in healthy ornamental ponds. Its growth is increased by bright sunlight and shallow fast running water so it will be found in water-falls and unshaded pond areas. Overstocked fish ponds can also contribute.

The simplest 'natural' treatment is to stock the pond with plants and animals that actively consume blanket weed or compete for the same food. Other highly successful methods include the careful use of copper ions, barley straw and pond vacuums.

Barley Straw - The Traditional method used since the middle ages



Safe to use. Not affected by recent HSE recall

PondXpert Barley Straw Essence

Effectively clears blanketweed and green water.

1000ml treats 22750Lts (5000 gal).

250ml **£8.99**
1Litre **£19.99**



PondXpert 'Throw 'n Go' Barley Balls

Biodegradable gel spheres packed with barley straw extract. Simply drop one ball per week into pond (each ball treats 5000l).

Barley Balls **£14.99**



Blagdon Barley Straw Bugs

Works like barley straw without the unsightly bales.

250ml RRP £17.99 **£15.99**
500ml RRP £32.49 **£27.49**
1ltr RRP £59.49 **£49.49**



PondXpert Twin Pack

The traditional method against blanket weed and algae. Float the net of barley straw just below the surface. Each bale treats 2250 Ltrs.

Twin Pack **£9.99**



Barley Straw Midi Bale

Larger bales for big ponds. Each log treats 13,500 Litres (3000 gallons) for 8 weeks

Midi bale RRP £29.99
Our Price **£14.99**



PondXpert Barley Flakes

Unlike traditional barley straw which sits on the pond surface these 'Flake' pouches are designed to sink to the pond bottom.

RRP £14.99
Our Price **£7.49**



Tetra AlgaFin

Effective and safe treatment for persistent blanketweed and other pond algae.



250ml (5,000) RRP £10.29 **£9.99**
500ml (10,000) RRP £17.12 **£15.99**
1ltr (20,000) RRP £28.61 **£24.99**

Pond Treatments - BlanketWeed Cures



Before



After



Buy 1 Get 1 Free with Blanketweed Beater Sixpack

Simply drop one water-soluble sachet into your pond or filter every week. Each sachet treats up to 4500 litres/ 1000 Gallons. **Pack of 6 £19.99**



Cloverleaf Blanket Answer

Add to the pond by pouring mixed powder /pond water evenly over the surface. 800g will treat ponds up to 10,000 litres. Awarded "Best in Test" by HDC Magazine.

0.2kg **NEW** Our Price **£8.99**
0.8kg Was £22.99 **Sale Price £17.99**
2.0kg Was £45.99 **Sale Price £39.99**
4.0kg Was £78.15 **Sale Price £69.99**
10kg **NEW** Our Price **£119.99**
25kg **NEW** Our Price **£269.99**



PondXpert Sludge Shifter

Soluble nuggets that contain a multitude of beneficial bacterial strains. Simply toss a nugget into your pond once a week to clear up sludge, odour and assist in re-balancing your ponds water quality. Six nugget pack - each nugget treats 4500 litres (1000 gallons).

RRP £39.99 **Our Price £19.99**



PondXpert Green Water Beater

Powdered solution contained in soluble bags. Friendly bacterial strains that positively affect your pond's balance. Toss a sachet into your pond once per week and it will dissolve to counteract poor pond nitrate and phosphate levels. Great for getting rid of slimy algae, odour and green water.

RRP £39.99 **Our Price £19.99**



Tetra PhosphateMinus 250ml

Reliably reduces high phosphate levels (PO4) in ponds, thereby preventing algae growth. One bottle treats 5000 litres of water.

RRP £11.34 **Our Price £9.99**



EA Stop Blanketweed

Kills and prevents regrowth of blanketweed. Powerful biocide which effectively does the job. 1 kg treats 10,000l.

1kg RRP £22.45 **Our Price £18.99**
2.5kg RRP £44.95 **Our Price £34.99**
4kg RRP £66.95 **Our Price £49.99**



Blanket Weed Brush

It's always best to hook out as much stringy blanketweed before you add any treatments. This brush with 1.8m telescopic pole is designed for the job.

RRP £43.98 **Our Price £15.99**

Save £5.99 on buying pole and head separately - see pg 67

Pond Treatments - BlanketWeed Cures

PondXpert Eliminator Treatments

Cure common pond water problems quickly & effectively. High quality safe soluble powders made up of beneficial organisms and natural minerals. Each 1kg tub treats 11,250 litres (2500 gallons).

BlanketWeed Eliminator	£19.99	Our Price £14.99
Green Water Eliminator	£19.99	Our Price £14.99
Sludge Eliminator	£19.99	Our Price £14.99
Variety Pack 3 for 2 Deal	£44.97	Our Price £29.99

Blanketweed Eliminator kills string algae & Sludge Eliminator disposes of the dead vegetation.

BlanketWeed & Sludge Twin Pack £29.99 **Our Price £24.99**



Variety Pack 3 for 2 Our Price £29.99



Blagdon Blanket Weed Algalway

Effective pond treatment against blanket weed & string algae.

Small treats 10,740 litres
RRP £22.49 **Our Price £17.99**
Large treats 45,845 Litres
RRP £50.99 **Our Price £40.99**



Nishikoi Goodbye Blanketweed

Does just what it says on the tub! Simply drop one water soluble bag into pond each week (each bag treats 4500l).

10 wk Tub £19.99
32 wk Tub £59.99



Blagdon Pond Balance

Safely and gradually adjusts your pond's water chemistry achieving a balance which clears blanketweed.

259g (2273l) **£15.49**
519g (4546l) **£23.99**
1557g (13638l) **£51.99**



Aquaplancton

Can clear green water, sludge, slime, odour, blanketweed & all types of algae. Dosage 450g per sqm (1lb per 10 sq foot).

1kg £29.99
1kg x 2 £44.99
1kg x 3 £64.99



Nishikoi Clear Waters

Powerful algicide - treats up to 10,000 Ltrs per kg. Works fast!

1kg £19.99
2.5kg £36.99
5kg £59.99
10kg £99.99



Blanc-Kit Excel

A tried & tested remedy for blanketweed. Add the specific amount required.

1500 (treats 6820l) **£9.99**
3000 (treats 13600l) **£16.99**
9000 (treats 40900l) **£39.99**



Evolution Aqua Blanketweed

New fast acting effective formula. 100% safe for fish & wildlife.

400g **Our Price £9.99** ponds up to 5000 litres
800g **Our Price £16.99** ponds up to 10000 litres
2kg **Our Price £34.99** ponds up to 25000 litres
4kg **Our Price £59.99** ponds up to 50000 litres

Liquid Bacterial Treatments - The *New* way to balance a pond

Evolution Aqua Pure Pond

Pure Pond Balls are packed full of healthy bacteria in a polymer shell. Add to your filter system to smooth out any peaks and troughs of the Ammonia/Nitrite cycle. Cleverly, the healthier your water the longer the balls last. 500ml treats 10,000 litres.

500ml £12.45
1000ml £19.45
2000ml £32.45



Evolution Aqua Pure Pond Bomb

Pure Pond Bomb is a highly concentrated version of the balls. Simply drop one straight into your pond or filter to clean up organic waste and break down the ammonia and nitrite.

Single £14.95
3 Pack £39.99



Evolution Aqua Sludge/ Pond Bomb Duo

Combo pack saves you £4.95

Our Price £24.95



Evolution Aqua Sludge Bomb

Cleans up organic waste and digests sludge.



Our Price £14.95

PondXpert Pond Gel Balls

"Pond Gel Makes Your Pond Well"

Special Offer - 3 for 2

Biodegradable balls water conditioning treatment. Simply pop them into your filter and they will slowly dissolve releasing millions of healthy bacteria and enzymes. Your pond will be brought gently back into balance as ammonia and nitrite issues are resolved. The balls also contain a clarifying agent to give the water a clear 'crisp' finish.

500ml of Gel Balls treats 15,000 Litres (3300 gallons)

Pond Gel Balls 500ml RRP £17.99 **Our price £8.99**
Pond Gel Balls 1000ml RRP £29.99 **Our price £14.99**
Pond Gel Balls 2000ml RRP £49.99 **Our price £24.99**

Special Offer - Buy 2 get 1 FREE (all sizes)

PondXpert Gel Balls 500ml Triple Pack £17.98
PondXpert Gel Balls 1000ml Triple Pack £29.98
PondXpert Gel Balls 2000ml Triple Pack £49.98
Throw n' Go Triple Pack £29.98



PondXpert 'Throw n' Go'

"Blow Your Pond Problems Away!"

This water conditioning treatment takes the form of 5 giant spheres. Each ball treats 5000 Litres (1100 gallons). It is a super sized version of pond gel as described above designed to be dropped straight into the pond.

Pack Treats 25,000 Litres (5500 gallons).

'Throw n' Go' RRP £29.99
Our Price £14.99



Filbert Frog's Top Tip

The smaller Gel Balls can be thrown straight into the pond as well as inside your filter. Put them in a mesh bag and you will know when they need replenishing. PondXpert Mesh Bag £7.99



Now 60% Free - 8 Balls for price of 5

Pond Treatments - Water Problem Solvers

Slimy Algae/Greenwater



Goodbye Greenwater

Simple water soluble sachets especially effective against slimy algae and greenwater.

8 wk treatment for 4500l **£14.99**



Tetra AlgaRem

Fast and environmentally friendly treatment for combating green water.

250ml (5,000) RRP £10.29 **£9.99**
 500ml (10,000) RRP £17.12 **£15.99**
 1ltr (20,000) RRP £28.61 **£24.99**



Green Away

Non toxic treatment clumps algae together so they sink or are removed by filter. See UVcs.

250ml (11,365l) RRP £13.99 **£11.99**
 500ml (22,730l) RRP £21.99 **£18.99**
 1ltr (45,460l) RRP £29.99 **£25.99**

Dirty Water



Sludge Buster

Contains millions of bacteria which actively consume organic sludge. Use after anti algae products.

9000 Ltr pack RRP £29.99 **£15.99**



Tetra Crystal Water

Effectively eliminates dirt particles clarifying your water. Works fast. Not suitable for sturgeon-like fish.

250ml RRP £13.99 **£9.99**
 500ml RRP £17.12 **£15.99**
 1ltr RRP £28.61 **£24.99**



Clear Pond

Clears dirty, cloudy water by clumping together fine suspended clouding particles, which then sink and clear pond water.

250ml (5,682l) RRP £13.99 **£11.99**
 500ml (11,364l) RRP £21.99 **£18.49**
 1ltr (22,730l) RRP £29.99 **£25.99**

PondXpert Particle Blaster (473ml)

Clears dead or suspended particles. Ideal for clearing dead blanketweed following Eliminator treatment.

Treats 22,340 litres

RRP £39.99

Our price £19.99



Dead Particles on pond floor



After Treatment

New Ponds: Any new pond build should be left unstocked until at least six weeks have elapsed in order to allow the pond's natural eco-balance to level. Beneficial 'friendly' bacteria will build up and breakdown any harmful toxins. A simple test kit will allow you to take water samples to measure ph (6-8 is ideal, 7 perfect), ammonia, and nitrate.

Water Testing Equipment



Tetra 7in1 Handy Test Pack

Test for Chlorine, pH, Carbonate, Hardness, Nitrite & Nitrate & CO₂. Handy pack of 25 tests.

RRP £15.99 **Our Price Only £13.99**



Blagdon Dip Test Kit

Quick & easy strip tests. Contains tests for ammonia, nitrite, nitrate, pH and water hardness. 60 tests.

RRP £19.58 **Our Price £16.99**



PondXpert Dip Tests

Quick result dip tests. Simply dip a test strip into pond to discover a range of six parameters. 50 tests.

RRP £19.99 **Our Price Only £9.99**

Blagdon Bio Start

Contains bio-cultures that balance pond. 4 sachets. treats 9000lts RRP £21.99 **£15.99**



Nishikoi Goodbye New Pond Problems

Contains bio-cultures. 2 soluble sachets

treats 9000lts **£7.99**



PondXpert Rapid Water Test Kit

- High quality liquid tests
- 7 parameters covered
- Up to 280 tests in total



Easy to use comprehensive water test kit with seven test parameters. Includes tests such as pH, ammonia, nitrite, hardness, nitrate and phosphate. Includes 7x liquid reagents, test tubes, pipettes, tray and instructions.

RRP £49.99 **Our Price £24.99**

Professional 'Liquid Style' Test Set!

Water Conditioners: Tap water is toxic to fish as it contains chlorine and other chemicals. This should be neutralised with a treatment. Alternatively collected rainwater can be used. Bacterial boosters add friendly bacteria to the pond quickly - speeding up maturation



Fibert Frog's Top Tip

Consider investing in an inline dechlorinator (pg86) to save £££

PondXpert Tap Water Tonic

Bestselling anti-chlorine treatment from PondXpert Includes a slime coat protectant.

473ml bottle can successfully treat 12,112 litres of water.

473ml RRP £39.99

Our price £19.99



Blagdon Fresh Start

Removes chlorine. 500ml treats up to 4,546 litres.

250ml RRP £13.99 **£11.99**

500ml RRP £21.99 **£18.49**

1litre RRP £29.99 **£25.99**



Tetra AquaSafe

Removes chlorine, 500ml treats up to 10,000 litres.

250ml RRP £11.34 **£9.99**

500ml RRP £18.87 **£15.99**

1litre RRP £31.54 **£24.99**



Pond Treatments - Fish Health



Blagdon Liquid Treatments Range 250ml treats 2273Lts (500 gal) 1litre treats 9092Lts (2000 gal).

 <p>Blagdon Pond Salt Small treats 2250l, Large treats 9000l. 2.27kg £11.99 9.08kg £39.99</p>	 <p>Blagdon Ammonia Remover Removes toxic ammonia & chloramine from ponds 500ml £18.49</p>	 <p>Blagdon Stress Away Keep disease away 250ml £11.99 1litre £25.99</p>	 <p>Blagdon Duckweed Buster Prevents the growth of duckweed. 250ml (2273l) £15.99 1ltr (9092l) £49.99</p>	 <p>Blagdon Anti-Fungus Treats fungus, finrot & mouthrot 250ml £11.99 1litre £25.99</p>
--	---	--	---	--

 <p>Blagdon Anti Ulcer Treats ulcers, gill disease and dropsy. 250ml £16.99 1litre £42.99</p>	 <p>Blagdon pH Adjuster Alkaline Ponds Takes ph below 8.5 treats 5675lts £11.49</p>	 <p>Blagdon pH Adjuster Acid Ponds Takes ph above 6 treats 5675lts £11.49</p>	 <p>Blagdon Anti Parasite Treats white spot, flukes & slime disease. 250ml £11.99 1litre £25.99</p>	 <p>Blagdon All in 1 Fish Treatment Help treat parasite, fungus and bacterial infections. Treats white spot & fin rot. 250ml £11.99 1litre £25.99</p>
--	--	--	---	--

Pond Treatments - Fish Health & Water Quality



PondXpert Concentrated Liquid Treatments Range

Extra concentrated for best value: 250ml treats 5680Lts (1250 gal) 1litre treats 22750Lts (5000 gal).

 <p>Total Pond Health Vitamin packed formulation promotes healthy water. 250ml £8.99 1litre £19.99</p>	 <p>Anti-Parasite Helps prevent parasite & ulcer. 250ml £8.99 1litre £19.99</p>	 <p>Anti Fungus & Bacteria Powerful disinfectant against fungal & bacterial ailments. 250ml £8.99 1litre £19.99</p>	 <p>Anti Blanket Weed Hydro gel technology safely controls algae. 250ml £8.99 1litre £19.99</p>	 <p>Anti Cloudy Water Water clarifying agent - controls murky or cloudy water. 250ml £8.99 1litre £19.99</p>
--	---	---	---	--

 <p>Anti Green Water Clears green looking water caused by algal growth. 250ml £8.99 1litre £19.99</p>	 <p>Anti Duckweed Tackles unwanted duckweed by roots and leaves. 250ml £8.99 1litre £19.99</p>	 <p>Anti Chlorine Makes tap water safe. Neutralises chlorine. Added Vitamin B1. 250ml £8.99 1litre £19.99</p>	 <p>Barley Straw Essence Effectively clears blanketweed and green water. 250ml £8.99 1litre £19.99 <small>Safe to use. Not affected by recent HSE recall</small></p>	 <p>Pond Salt Improves fish health and improves natural eco-balance. 500g treats 2250 litres 1kg treats 4500 litres 500g £8.99 1kg £14.99</p>
---	--	---	--	---

Fish Food



Fibbert Frog's Top Tip

Only feed once a day at season end/start (5-8°C). In summer (10°C) can feed 2-3 times. Remove any uneaten food after 5 minutes.

In established pools, where there is a good balance of plants, wildlife and fish there will be plenty of natural food for your fish to feed on.

However, pond food acts as a supplement to the fishes' diet and is enjoyable for the pondkeeper.

Often ponds will be more heavily stocked and there may not be enough plant life to attract insects.

Here feeding is vital to the health of the fish. High protein foods should be fed in the summer with only low protein (eg, wheatgerm) fed in the winter.

Tetra Floating Sticks

A complete staple food for all fish. The UK's bestselling pond food.

780g	£16.99
1.2kg (10ltr bucket)	£21.99
1.68kg	£29.99
3.0kg	£39.99
4.2kg	£49.99



Tetra Koi Sticks

A complete food for all koi. High digestibility. 31% protein.

650g	£15.99
1.1kg	£23.99
1.5kg (10ltr bucket)	£29.99
2.35kg	£39.99
7.5kg	£99.99



Tetra Variety Sticks

A mix of pond, koi and wheatgerm sticks for all fish.

600g	£14.99
1.02kg	£21.99
1.65kg (bucket)	£29.99
2.12kg	£39.99
4.10kg	£54.99



Nishikoi Staple Food Pellets

A floating food that is a complete diet for all pond fish. 28% protein.

750g	£12.49
1.250kg	£19.99
2.5kg	£29.99
5.0kg	£44.99
10.0kg	£69.99



Nishikoi Growth Food

A floating food promotes health & steady growth. 37% protein.

750g	£16.99
1.250kg	£24.99
2.5kg	£39.99
5.0kg	£59.99
10.0kg	£89.99



Pond Feeding Equipment



The future of feeding has arrived...

Sale £30



PondXpert FoodFlinger Pond Fish Feeder

Feeds your fish when you are not available. New Auto-Feeder with solar power. Very easy to use with full control via LCD control panel. Clever anti-clog design means regular, reliable feeding.

RRP £239.99 Was £149.99 **Sale Price £89.99**

Super Features

- Rechargeable batteries powered by solar
- 6 Litre capacity accepting pellet & stick food
- Control size of feed (0 to 20 seconds)
- Control number of daily feeds (1-6)
- Control 'scatter power' (60-100%) distance

Accepts pellet & stick style food 3-10mm.

Includes 4 stake feet for optional additional stability.

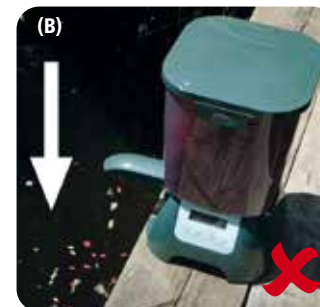

(A) PondXpert FoodFlinger offers powered propulsion. Food can be propelled a controllable distance (3ft to 10ft) at wider arc of 160 degrees.

- Allows multiple siting opportunities
- Fair distribution of food enabling all fish to feed

(B) Traditional 'auto-feeders' can be troublesome to position pond-side. The food drops down vertically from a chute into the water. Greedy fish can monopolise meals.

FoodFlinger Mains Adaptor

FoodFlinger powers its rechargeable batteries (supplied) via an integrated solar panel. One charge lasts up to 3 months but an optional Mains Charger is available.

RRP £19.99 **Our Price £9.99**



Introducing

pondXpert
nutrition+ Pond Food

Nine super varieties to cover all pond fish requirements.

Seven mainline foods available in three handy sizes:

1KG Bags

4Kg Bags

10kg Bags

(Save 50% buying a 10kg bag vs 1kg).



Bestselling Food Range Improved

Food Variety	Description	Protein
Mixed Blend	Triple blend - 2 colour sticks & pellet mix	28%
Growth Pellets	4mm diameter round pellets	32%
Koi Sticks	Classic stick shaped food for koi and all fish	29%
Pond Sticks	Classic stick shaped food for all fish	27%
Oranges & Cream	Classic mixed colour sticks food for all fish	28%
Staple Pellets	5mm diameter round pellets	27%
Wheatgerm	Easily digestible pellets, perfect for winter	22%
Pond Flake	Crumbles in hand	16% 800g bags only
Bottom Sinking	4.5mm pellets for sturgeon & sterlets	34% 2.5kg bags only

All foods include vitamins, minerals & spirulina for fish health.

Sinking Pellets

High protein food designed specifically for bottom-feeding fish such as sturgeon, sterlets.

Remember to observe fish activity throughout year as some bottom feeders will continue to feed in winter.

Approx. 3.6 Litres

2.5 kg RRP £39.99

Our Price £19.99



Pond Flake

Perfect for all fish but particularly small or medium surface feeding fish in your pond.

Flakes break down into smaller pieces and are easily digestible.

Approx. 4 Litres

800g RRP £39.99

Our Price £19.99



Orange & Cream Sticks

Mixed colour sticks. A great 'allround' food and suitable for all surface feeding fish.



1kg
4kg
10kg

£9.99
£29.99
£49.99



All Foods available in 3 handy sizes. Save 50% per KG with our bulk bags.

FREE
"Taster" Sample Packs Available, phone for details

Mixed Blend

Popular blend of sticks and pellets. Various piece sizes make this a great choice for mixed fisheries.



1kg
4kg
10kg

£9.99
£29.99
£49.99

Koi Sticks

Higher protein food designed specifically for koi and other large fish.



1kg
4kg
10kg

£9.99
£29.99
£49.99

Pond Sticks

Popular food for goldfish, koi and all other surface feeding fish.



1kg
4kg
10kg

£9.99
£29.99
£49.99

Wheatgerm Pellets

Low protein food, easily digestible (4mm), perfect for feeding during winter and early spring.



1kg
4kg
10kg

£9.99
£29.99
£49.99

Staple Pellets

As the name suggests a food perfect for regular feeding throughout the year. Suitable for all fish.



1kg
4kg
10kg

£9.99
£29.99
£49.99

Growth Pellets

High protein food designed specifically for growing-on of koi during the warmer months.



1kg
4kg
10kg

£9.99
£29.99
£49.99

Pond Feeding Equipment

Hozelock Automatic Fish Feeder



Indispensable for holiday feeding, the Automatic Fish Feeder can be mounted on a pond wall or on the supplied stand. Operate via a single control incorporating a battery-operated clock and a frequency dial which gives a choice of up to six feeds per day. The food chamber holds up to 800ml (approx. 100g) of fish food.

RRP £205.39 **Our Price £109.99**



Fishmate Fish Feeder

Automatic fish feeder for up to 21 days. Reliable and accurate timer AA battery included.

RRP £59.90 **Our Price £49.99**

Fish Mate P7000 Pond Fish Feeder

FISH MATE

Suited to larger ponds for use with pellet or 'stick' food. Variable feed sizes are dispensed at programmed times or on demand at the touch of a button.

- 7 Litres/ 6.5lbs / 30 cup capacity dry food hopper.
- Easy to use LCD control with approximately 6 to 9 months battery life in continuous use.
- Unique feed mechanism ensures accurate and consistent feed sizes from teaspoons upwards.
- Weather-resistant
- Can be fastened to a secure base for increased stability.
- Suitable for most popular food sticks and pellets

Fishmate P7000 feeder RRP £115.23 **Our Price £84.99**



PondXpert Thermometer

Knowing the correct water temperature of your pond water is vital when to feed and add treatments. This floating thermometer gives you the information you need.

RRP £19.99 Was-£9.99 **Sale Price £7.99**



PondXpert Feeding Ring

Floats on surface and allows easy removal of uneaten food & prevents food drifting around surface.

RRP £4.99 **Our Price £2.49**



Supa Vacation Block

Concentrated block of fish food that will supplement the diet of your fish for up to two weeks.

- 50 gramme block
- Protein 40%, Fat 8%, Fibre 2%, Moisture 8%

RRP £2.99 **Our Price £2.49**



Tetra Holiday Food

One block feeds 10-15 medium sized goldfish, or 2-3 medium sized koi, for 14 days. If your pond contains more fish, increase the number of blocks accordingly.

RRP £8.99 **Our Price £6.99**



Pond Side Creatures

Floating Ducklings (triple)

Set of 3 cute ducklings to complete the duck family.

1 Ducklings RRP 19.99 **£9.99**

Dimensions: LWH cm 11 x 6 x 6



2 Owl £12.99

Can be filled with sand for extra ballast or hung from tree (pierce hanging slot). Dimensions: LWH cm 16 x 16 x 42 (6' x 6' x 1'5")



Ducks

4 Mallard Male £9.99

5 Mallard Female £9.99

Dimensions: LWH cm 13 x 35 x 13 (5" x 1'2" x 5")



6 Wind-Action Owl £24.99

Ornamental bird with spinning head that works as a pest deterrent.



Swans

7 Swan Small £19.99

8 Swan Large £39.99

Swan Pair £49.99 **Save £9.99**

'Pair' = Large & Small Swan

Dimensions: LWH cm

Small 33 x 18 x 24 (1'1" x 7" x 9")

Dimensions LWH cm

Large 81 x 33 x 41 (2'8" x 1'1" x 11'4")



"Adds a touch of majesty to our pond"

"Really nicely made and float well"



Pond Lighting

PondXpert Brightpond LED

New energy efficient outdoor and submersible LED Garden/Pond Lights perfect for illuminating your garden or pond. Supplied with a variety of coloured lenses, easily interchangeable by simply twisting-off the lamp cover.

Each lamp has a total of 12 LED Bulbs for a bright and energy efficient illumination. Each lamp set includes a weighted tripod and suction pads for easy placement.

Lense Colours Included:

White, Green, Red, Blue, Orange.

LED Lamp Power: 1w, 12v Safety Transformer, Transformer with 2 Meter Cable, 10m Cable from Transformer to 1st Light, then 1.2m between each Subsequent Light.

Quad supplied as 2xDuo set (2 transformers)

Quintet supplied as 1xDuo and 1xTrio set (2 transformers)



BrightPond LED Duo	RRP £99.99 £49.99
BrightPond LED Trio	RRP £119.99 £59.99
BrightPond LED Quad	RRP £149.99 £74.99
BrightPond LED Quintet	RRP £159.99 £79.99



← Halogen v LED →

Traditional halogen offers a warmer light with yellow tinge.

LED lights are 'sharper' and 'whiter' with a narrower beam

LED bulbs last longer and take less power to illuminate

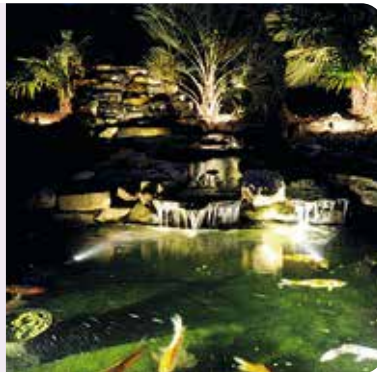

PondXpert Brightpond Halogen Pond Lights

Single 20w	RRP £69.99 Our Price £34.99
Duo Set (2 x 20w lamps)	RRP £99.99 Our Price £49.99
Trio Set (3 x 20w lamps)	RRP £119.99 Our Price £59.99
Quad Set (4 x 20w lamps)	RRP £149.99 Our Price £74.99
Quintet Set (5x 20w lamps)	RRP £159.99 Our Price £79.99

Product Description

Attractive pond lights suitable for use above or below water. These lights are easy to position thanks to weighted tripod stands and ground stakes (included)

Each powers a 20w halogen bulb and comes complete with transformer and four coloured discs.

2m Cable from plug to weatherproof transformer, then 5m to first Light, then 2m to Subsequent Lights.



Pond Lighting



The right lighting enables you to create limitless effects in your garden.

Lighting displays are magnified by the reflective nature of water while fountains and waterfalls look even more dramatic at night.



PondXpert Pondlight LED 3

This triple 5 Watt* LED spotlight set can be used in or out of the water. The three lights are connected to a low voltage 12v/30w transformer for safety.

- Adjustable light angle.
- 5m electrical cable between transformer and first light - 1m between each other light
- Supplied with 3 packs of 4 coloured lenses: red, green, yellow and blue.
- 1 year guarantee

RRP £79.99

Our Price £39.99

*3 x 1.6W

- Special Offer -
Twin Pack £79.98
Our Price £59.99



Use in or out of the water

New - Dawn to dusk sensor automatically turns lights on at night

Pond Lighting

SolarSublight SUPER - Premium Solar Submersible Lighting

Powerful solar lighting with enhanced solar power and higher capacity lithium batteries. Includes brightness level option (High/Low).

All models supplied with extra-power 3.5W Panel and high capacity lithium battery

SolarSublight SUPER Quad Set

A set of FOUR solar underwater lights.

Two lengths of main cable allow for extended positioning possibilities for the consumer.

Specifications

Solar Panel: 3.5 Watts

Lithium Battery: 3.7v/3600mAh

Lighting Power: 1.2W per light (144 lumens)

Set illumination: 4.8W / 576 lumens

Cable Length: 3 mtrs x 2 (1.15m between lights)

Running Time

Low Light: 24 hrs High Light 12 hrs Charge time: 8 hrs



'Warm White' colour

Model	Lamp Power	Battery	Power Cable	Running Time Hrs		WAS	SALE PRICE
				Low Light	High Light		
SolarSublight SUPER Triple White	1W	3.7v/2200mAh	3m+1.15m x 2	14	7	£49.99	£34.99
SolarSublight SUPER Triple RGB	1W	3.7v/2200mAh	3m+1.15m x 2	n/a	10	£54.99	£39.99
SolarSublight SUPER Quad White	1.2W	3.7v/3600mAh	3m x 2+1.15m x 3	24	12	£59.99	£49.99

Our most powerful solar lights - Twice the Brightness!



SolarSublight SUPER Triple Set RGB

Auto-Cycle Colours auto-rotate between approx 7 colours
Fixed Colour Lights can be fixed on Red, Green or Blue.

SolarSublight SUPER Triple Set

Choose between Low/High Brightness Illumination



Dusk 'til Dawn Auto illumination

Pond Lighting

PondXpert Solar Submersible Lighting

Waterproof solar powered LED spotlights that can be used in or out of the water. Lights will illuminate automatically at night for 8 hours if battery fully charged.

Lamp power 0.4W



'Bright White' colour

Model	Power	Power Cable	RRP	Was	SALE PRICE
Solar SubLight Single Light White	0.3w	3.2m	£49.99	£24.99	£19.99
Solar SubLight Duo Lights White	0.6w	3.2m	£59.99	£29.99	£24.99
Solar SubLight Triple Light White	2.5w	3.2m+1.15m	£79.99	£39.99	£29.99
Solar SubLight Triple Light Colour	2.5w	3.2m+1.15m+1.15m	£99.99	£49.99	£34.99

Lighting Modes (RGB Only)

Fixed colour - green, blue or red.

Multi colour - cycles through RGB.

2 in 1 Installation



Triple Sets Lithium battery, others Nimh.



Pond Plants

Water gardens give the keen horticulturist an opportunity to grow a number of aquatic-friendly species.

Introducing plants to your pond is beneficial for optimising 'pond balance'.

Live Pond Plants

We are delighted to be able to offer you a top selection of plants from the UK's best aquatic nursery. Our customers love our Variety Packs of Six 9cm plants - Your Pack of 6 will be made from a selection of 13 plants. These will be chosen by the nursery pickers based on availability and quality of the plants at time of despatch (ie, what is in-season).

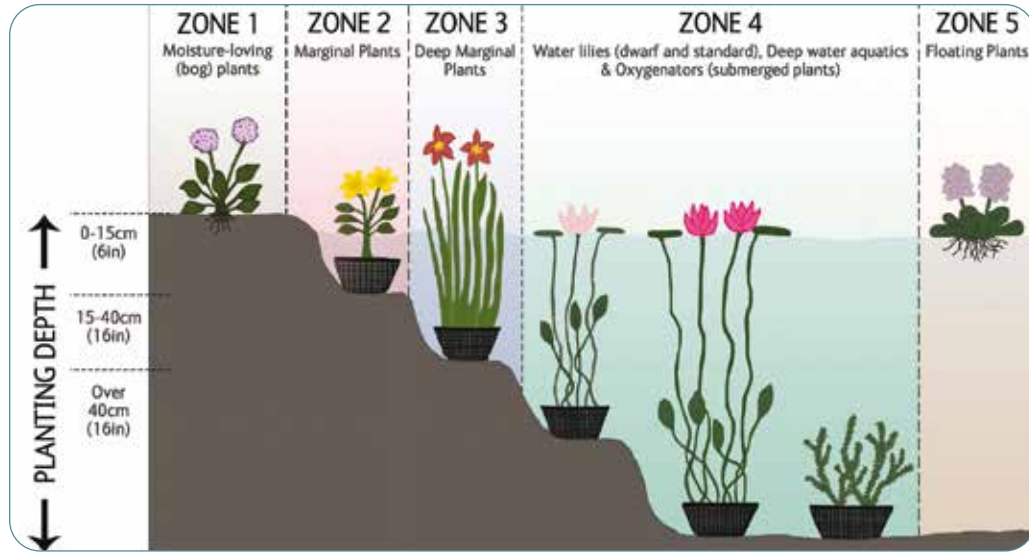

★★★★★
100%
5
Customer Reviews

Ornamental Marginal Variety Pack

Marginal Plants grow well in wet or water logged soil near the water garden's edge or in shallow water.

Our Price £49.99



★★★★★
100%
9
Customer Reviews

Oxygenator Plants Variety Pack

Submerged beneath the water's surface, these plants release oxygen into the water (essential for a healthy pond).

Our Price £49.99



★★★★★
100%
4
Customer Reviews

Wildlife Marginal Variety Pack

Great Pollinators as well as being British Natives. Will attract a wide variety of pollinating insects and other wildlife.

Our Price £49.99

Water Lilies (1 ltr pot)

Spectacular flowering plant.

- Red Lily £24.99
- White Lily £24.99
- Yellow Lily £24.99



Pond Plants

As well as looking beautiful aquatic plants play an important part in keeping your pond balanced. Plants absorb nutrients, reduce light levels in the water and produce oxygen. Plants also provide shelter for fish and natural material on which they might spawn.

Planting Baskets

Aquatic planting baskets have been designed with mesh to help retain the soil. A fabric liner can be used to reduce any soil leaching.



★★★★★
100%
37
Customer Reviews

3 for 2

How to choose a planting basket size.

Submersed Plants: 10cm wide or kidney shape and larger.

Bog Plants: 18-23cm wide for small bog plants, 28-36cm wide for large bog plants like Iris. Kidney shape baskets are also great for arrangements of 3-4 young bog plants.

Water Lilies: 20-25cm wide work for Dwarf lilies, but for regular lilies we recommend the XL 40cm size.



Fibbert Frog's Top Tip

Did you know a 10 litre bag of soil will fill 1 x kidney basket? In order to help you decide how much soil you need we have added a 'capacity' column next to our planting baskets. Hope this helps!

Planting Bag

Easy to use, more flexible than baskets, fit in small areas.

3 for 2

★★★★★
100%
5
Customer Reviews



PLANTING BAGS		
Type (L x W x D) cm	Triple	Single
Small round 15 dia x 15	£2.99	£1.49
Med. round 25 dia x 20	£3.99	£1.99
Small square 18 x 18 x 18	£2.99	£1.49
Med. square 25 x 25 x 20	£3.99	£1.99
Large square 30 x 30 x 25	£4.99	£2.49

PondXpert Hessian Squares

Traditional material used for lining baskets. 45cm x 45cm Pack of 3.

RRP £7.99 **Our Price £3.99**



★★★★★
100%
8
Customer Reviews



Fine Lining Squares 5 pack

Vey fine mesh means no soil can escape with this black fibre. 50x50cm **Our Price £2.99**
100x100cm for lily basket. Single RRP £3.99 **Our Price £1.99**

★★★★★
90%
10
Customer Reviews



"Fat" Kidney Baskets
37 x 24cm **£1.99** **£3.99** for 3

PLANTING BASKETS			
Type (W x D) cm	Volume	Triple Pk	Single
Small round 14 dia x 10	1 ltr	£1.99	£0.99
Med. round 21 dia x 13	3 ltr	£3.49	£1.99
Mini square 11 x 10	1 ltr	£1.99	£0.99
Small square 20 x 10	2.5 ltr	£2.99	£1.49
Med. square 24 x 15	5 ltr	£3.99	£1.99
Large square 29 x 20	10 ltr	£4.99	£2.49
"Thin" Kidney 45 x 18	8 ltr	£3.99	£1.99
Xlarge square 31 x 25	12 ltr	£6.99	£3.49
Lily basket 40 dia x 29	30 ltr	£15.99	£7.99

Plant Sock

Plant/soil holder which can be formed into a flexible 'sausage' shape. Buttons then stop soil falling out. Great for nooks & crannies.

- Small Sock 10dia x 80cm **£7.99**
- Large Sock 15dia x 80cm **£8.99**



★★★★★
100%
2
Customer Reviews

Pond Plants 'Dry' Plant Selection from Holland

These 'dry pack' plants represent a great saving compared with "wet plants". Being dry packed means plants can be stored until you are ready to plant, or they can be given as great gifts.

Moerings Plant in a Basket

Dried plants packed in a planting basket. Supplied with plant, soil and gravel (as shown in bottom right hand corner of this page).

Contents:

1 x 19x19x10cm basket 2 plants per basket 1 lily per basket.

Grow
Pond Plants
Anywhere!



Iris £8.99



Typha £8.99



Acorus £8.99



Pontederia £8.99



Yellow £9.99



Red £9.99



White £9.99



Pink £9.99



Moerings Floating Ring Kit

Square Floating Planter (20 x 20cm) and 3 plants. Plants randomly selected depending on season.

£12.99



Over Liner Mat Planting Mat

Planting material with pockets. Hide exposed liner with plants for a more natural look.

1.10 x 1.05m

RRP £22.00

Our Price £14.99



All Plant kits contain everything you need

Packs include

plant(s), soil, planter and gravel.



PondXpert PondBloom Fertiliser

Designed to keep aquatic plants vigorous and beautiful. Simply use 1-2 tablets monthly per 3-4 litres of soil. 5 tablet pack.

RRP £9.99

Our Price £4.99



Pond Plants

Aquatic Soil

Premium, fertiliser free. Suitable for all plants. 20kg - let us take the strain!

10 Litres £7.99

20 Litres £12.99



Pond Gravel

Cover material for soil and plant baskets. Gravel size 4/6mm

8 Litres £7.99

2 Litres £4.99

New
Mini Pack



- Special Offer -
10l soil & 8l gravel combo deal £14.99

PondXpert Floating Planters

A beautiful way to display pond plants

- Plants kept watered automatically
- Planters can be joined together

Round Planter Small

(25cm) RRP £19.99 £9.99

Round Planter Medium

(35cm) RRP £29.99 £14.99

Square Planter Small

(25cm) RRP £21.99 £10.99

Square Planter Medium

(35cm) RRP £31.99 £15.99



Velda Floating Plant Oasis

Floating planter island suitable for 6 x 9cm plug plants. Dimensions 40 x 30 x 5 cm (LWH).

Floating Plant Oasis
Our Price £9.99

Free
Pots
worth
£2.94



Our Best Ever Floating Planter Deal!

Round

Planter Set

(25cm + 35cm)

£24.98 £17.99

Square

Planter Set

(25cm + 35cm)

£26.98 £19.99

Save £6.99



Pond Plants

Artificial plants offer an attractive option to growing the real thing.

They add a touch of instant colour, require zero maintenance and can't be eaten by any fish you may have in the pond.



Note: colours vary

Floating Lily Set

Triple Pack
Dimensions:

20cm, 18cm, 10cm

Artificial Lilies

RRP £29.99

Our Price £14.99



Artificial - Underwater Plants

Artificial Pond Plants - Underwater Oxygenators 1m height (50cm height Ideal for preform ponds & shallow ponds).



- Artificial Oxygenator (A) 50cm** RRP £19.99 **£9.99**
- Artificial Oxygenator (B) 50cm** RRP £19.99 **£9.99**
- Artificial Oxygenator (C) 50cm** RRP £19.99 **£9.99**
- Artificial Oxygenator (D) 50cm** RRP £19.99 **£9.99**
- Artificial Oxygenator (E) 50cm** RRP £19.99 **£9.99**

- Artificial Oxygenator (A) 1m** RRP £39.99 **£19.99**
- Artificial Oxygenator (B) 1m** RRP £39.99 **£19.99**
- Artificial Oxygenator (C) 1m** RRP £39.99 **£19.99**
- Artificial Oxygenator (D) 1m** RRP £39.99 **£19.99**
- Artificial Oxygenator (E) 1m** RRP £39.99 **£19.99**

- ✓ **Bestselling decorative item**
- ✓ **Fish use plants for spawning. Much more attractive than 'brushes'**

- ✓ **Add instant colour to a new pond**
- ✓ **Creates a spectacular dancing underwater feature when placed above air pumps**

PondXpert PondBloom Fertiliser

Designed to keep aquatic plants vigorous and beautiful. Simply use 1-2 tablets monthly per 3-4 litres of soil. 5 tablet pack.

RRP £9.99

Our Price £4.99



Velda Growth Balls

Convenient pack of 50 fertiliser tablets. Perfect for enhancing growth of all pond plants including lilies and marginals.

RRP £5.29

Our Price £4.99



Pond Hose Fittings

Universal Flow Regulator

Adjust pump flow
20 / 25 / 32 / 40mm

Blagdon

RRP £30.49

Our Price £27.99

Hozelock

RRP £26.79

Our Price £24.99



Hozelock 25mm Flow Regulator

Flow restrictor
25mm (1")

RRP £9.69

Our Price £8.99



Laguna Universal Joiner

Joins all hose sizes

5-20mm RRP £4.69

Our Price £3.99

20-40mm RRP £7.99

Our Price £6.99



PondXpert Universal Joiner

Joins hose
20/25/32/40mm

RRP £25.99

Our Price £12.99



Small 'T' Piece

Joins hose
12/20/25mm

RRP £9.79

Our Price £8.99



Large 'T' Piece

Joins hose
40/32/25/20mm

RRP £19.69

Our Price £16.69



PondXpert Universal Flow Regulator

38/32/25mm (down to 20mm one end).

RRP £39.99

Our Price £19.99



Threaded Hosetails

3/4" (20mm) Hose 12-25mm **£5.29**

1 1/4" (32mm) Hose 20-40mm **£5.79**

1 1/2" (40mm) Hose 20-40mm **£6.49**



Rigid Pipe

2" width x 150cm **£9.99** (G2Clean/Clear Pond)

70mm width x 48cm **£9.99** (Biotec, Filtobox 12/25)

70mm width x 100cm **£14.99**

70mm elbow 45 deg **£7.99**

70mm elbow 90 deg **£7.99**

3" x 3m pressure pipe **£39.99**

4" x 3m pressure pipe **£49.99**



Evolution Aqua Eazy Connectors

Flexible PVC fittings make connections from outlets to pipework easy. No messing with glue or solvents.

Straight 2" connector **£7.49**
(63-50mm)

Straight 1.5" connector **£5.49**
(50-38mm)

2" to 1 1/2" Adaptor **£7.99**

3" to 2" Adaptor **£10.99**

4" to 1 1/2" Adaptor **£16.99**

4" to 2" Adaptor **£16.99**

4" to 3" Adaptor **£16.99**

2" Elbow (63-50mm) **£8.99**

1.5" Elbow (50-38mm) **£6.99**

1.5" End cap (50-38mm) **£4.99**

2" End cap (63-50mm) **£5.49**



Pond Hose Fittings

PondXpert 'Y' Pieces

Split your water flow and control flow rate with taps.

Small (20/25mm) RRP £39.99

Our Price £19.99

Large (20/32/40mm) RRP £49.99

Our Price £24.99



Small 'Y' piece



Large 'Y' piece

Pond Spares & Consumables

Here at pondkeeper we are keen to ensure that we provide everything you need to make your hobby a pleasure. Over the years we have developed a significant inventory of spare parts and consumable items (eg, replacement foams for filters and pump impellers). For a comprehensive list please visit the 'pond spares' section of our website or call us with any query you have.

Filter Foam Media



Filtobox 6000 £14.99
Filtobox 12000 £19.99

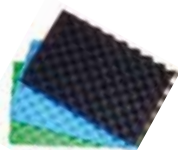

Triple Layer Foams
17 x 11" (43 x 28cm) £9.99
25 x 18" (64 x 46cm) £19.99
43 x 21" (110 x 53cm) £39.99
Trim to size - suits most box filters



Fine Foam Media
17 x 11" (43 x 28cm) £3.49
25 x 18" (64 x 46cm) £7.99
43 x 21" (110 x 53cm) £14.99
Trim to size - suits most box filters



EasyFilter 4500 (2 foams) £14.99
EasyFilter 9/12000 (3 foams) £16.99
EasyFilter 20/30000 (2 foams) £19.99



Bioforce Rev Foams Pack £34.99
1Pack for 6000 & 9000
2 Packs for 14000



EasyClear Single £14.99
EasyClear 3000 (1) £14.99
EasyClear 6000 (2) £19.99
EasyClear 9000 (3) £24.99

Decorative Solar Lighting Sale - All lines reduced by 50%

PondXpert Solar Orbs 4 Pack
Was £29.99 **NOW £14.99**



PondXpert Solar Rope
Was £24.99 **NOW £12.49**



PondXpert Solar Lilies
Was £29.99 **NOW £12.99**



Pack of Three

Many more SALE items online

ShedShield EPDM

Shed Roof Kits

Pondkeeper has been a rubber sheet specialist for nearly 20 years. Now we are offering you the chance to waterproof your garden buildings as well as your pond!

As a volume buyer of rubber lining we are able to buy in bulk direct from the factory. This enables us to pass onto you highly competitive Roof Kit deals.



Perfect For

- Sheds & Summerhouses
- Office Rooms & Cabins
- Play houses & storage



* Savings based against post-promotion pricing

Each Kit includes:

- Rubber EPDM single sheet 0.8mm
- EPDM Mastic 310ml
- Water Based Deck Adhesive 2.5L
- Roller applicator
- Instllation instructions

Shed Size Imperial	Shed Size Metric	EPDM Liner Size	Standard Price	OFFER PRICE	You Save
6 x 4ft	1.83 x 1.22	2.1 x 1.7m	£63.60	£53.00	£10.60
7 x 5ft	2.13 x 1.52	2.5 x 2.0m	£80.40	£67.00	£13.40
8 x 6ft	2.44 x 1.83	3.0 x 2.5m	£106.80	£89.00	£17.80
10 x 6ft	3.05 x 1.83	3.5 x 2.5m	£118.80	£99.00	£19.80
10 x 8ft	3.05 x 2.44	3.5 x 3.0m	£137.99	£115.00	£22.99
12 x 10ft	3.66 x 3.05	4.0 x 3.5m	£172.80	£144.00	£28.80
14 x 8ft	4.27 x 2.44	5.0 x 3.0m	£187.20	£156.00	£31.20

Each EPDM Sheet includes 30cm of spare material on the length and width and can be easily trimmed to final size with scissors.

Note: Rubber roofing sheets include factory welded seams universally typical of the vulcanising process.

EPDM rubber is a superior roofing material compared to shed felt

Bitumen Roofing Felt

Affordable roofing supplied with many outbuildings in the UK. Joined on-site. Low-cost benefits are unfortunately outweighed by lower performance and higher maintenance levels. Felt is not UV protected so will degrade quite quickly Around 5 years lifespan is typical.



EPDM Waterproofing Membrane

Supplied as a single sheet. Guaranteed for 20 years - 50 year+ expectancy UV Stable Maintenance free Tear resistant.



Pond Hose & Clips

As your pond water makes its journey from your pump to its destination - via a UVC, filter or waterfall - it needs to be constrained by a network of hose. This hose should be fixed securely to the equipment using clips - this helps prevent any chance of the hose becoming loose or leaks affecting performance. As with most things items fail due to the weakest link, that is why we only use premium hose and accessories.



PVC Pond Hose

Features:

- Smooth bore-minimal flow restriction
- Will not kink or split
- Convenient 5m lengths will suit most ponds



Clips

Features:

- Zinc plated, will not corrode
- Easy to tighten



Filbert Frog's Top Tip

Use the largest size of hose available for the equipment involved - this results in less frictional loss resulting in optimal performance.

PRODUCT DESCRIPTION	Size 12mm	Size 20mm	Size 25mm	Size 32mm	Size 38mm	Size 40mm	Size 50mm
5m Pre-cut Hose	£12.99	£14.99	£18.99	£24.99	£29.99	£29.99	£47.99
Bulk Length Hose	30m	25m	30m	30m	30m	25m	20m
Bulk Hose length Prices	£59.99	£69.99	£79.99	£109.99	£134.99	£134.99	£229.99
Zinc Hoseclips (pair)	£3.49	£3.99	£4.49	£4.69	£4.79	£4.79	£5.29
Union Hose Connector	£2.69	£2.89	£3.19	£5.89	n/a	£7.29	n/a

Order Information

Delivery

Delivery is direct to your door from our warehouse and we aim to despatch all orders placed before 1pm on the evening of the same day. Your order will be despatched on a 24hr service and be with you the next day (anytime 8am-6pm). *A standard charge of £4.99 is made to contribute towards handling and despatch. This charge is for mainland UK only - the following areas please ring for quote first (Isle of Man, Wight & Scilly, Northern Ireland, Channel Isles plus Scottish Highland & Island postcodes (BT, AB31-38, AB40-56, HS, IV, KA27-28, KW, PA20-88, PH4-44, PH49-50, ZE).



Please pass on to a friend or recycle

Returns

If any item does not meet your expectations you may return it (unused) within 30 days of purchase. We will cover the cost of return for damaged or faulty goods. Please state whether you would like a refund or replacement when returning goods. Your statutory rights are not affected.

Warranties

Most of our products come with free extended manufacturer warranties. If you incur any problems during this warranty period please let us know and if the item can not be fixed we will offer a replacement no problem. Proof of purchase required

Mailing List

- Please remove me from your mailing list
 - We may make our customer list available to carefully selected companies.
- Please tick if you do not want to receive such mailings

Products in this catalogue may differ slightly from the published photograph. All products and prices are correct at time of printing (E&OE), subject to availability and may be subject to change (customers will be notified of any changes before ordering). All sizes and specifications quoted are approximate only. Whilst every attempt is made to deliver your order promptly and in perfect condition Pondkeeper denies any liability for consequential loss or expense caused by faulty items or delay in despatch or delivery. We strongly recommend that no arrangements for installation involving third party contractors are made until you are in receipt of your goods and have checked they are satisfactory. Copyright Armstrong Direct Ltd trading as pondkeeper reg'd in England 5601027.

All-In-One Pump

Fountain pump with integrated UVC to combat green water. 13W UV. 1000lph
SALE PRICE **59.99**



Pond Filter Pumps

PondForce Pond Filter Pumps

Compact filter pumps designed to run 24/7 to pump water to a filter or waterfall. Solids-handling (up to 4mm particles) and low running costs.



Save £20

Model	Max Flow	Hose Size mm	Max Head Height	Power	WAS	SALE PRICE
PondForce 2300	2300LPH	20/25	2m	35W	£54.99	£34.99
PondForce 3000	3000LPH	20/25/32	3m	55W	£64.99	£44.99
PondForce 4700	4700LPH	20/25/32	3.5m	60W	£74.99	£54.99
PondForce 6200	6200LPH	20/25/32	4m	90W	£84.99	£64.99

Mechanically adjustable flow-rate.

Penny wise pond supplies



Fountain Pumps



Save £20

SuperJet Fountain Pump

Quality fountain pumps with two fountain displays (tiered & bell)

2300LPH ~~£59.99~~ **£39.99**
3000LPH ~~£69.99~~ **£49.99**
4700LPH ~~£79.99~~ **£59.99**
6200LPH ~~£89.99~~ **£69.99**

Low running costs
20/25/32mm outlet
*20/25mm 2300

Pond Vacuum

SludgeMuncher Pond Vacuum

Bargain pond vac with auto-empty feature and powerful 1400W motor. Ideal tool to help spring-clean your pond.

Pond Vac ~~£99.99~~ **£79.99**

Pond Vac + Discharge Bag Combo Deal **£99.99**

Save **£45**



Save £20

UV Pond Filter

Turn2Clean UV Pressure Filters

Featured-packed entry level filters. Easy maintenance with 'Easy Clean' technology. UVC included.

NEW 9000 & 12000 models with improved features inc. dedicated waste outlet



Save £20

Model	Pond Size Lts	UV Watts	WAS	OUR PRICE
T2C 3000	3000	11	£99.99	£79.99
T2C 5000	5000	13	£119.99	£99.99
T2C 9000 NEW	9000	13	£139.99	£119.99
T2C 12000 NEW	12000	18	£159.99	£139.99

Pump and Filter Sets

Turn2Clean Pump & Filter Sets

Pump & Filter Sets inc. hose (5m x 20mm). 2 yr guarantee.

Also available:

T2C 15000 Set **£239.99** See
T2C 20000 Set **£279.99** Pg58

Save even more!

Save up to £35



Set Name	Pump in Kit	OUR PRICE	Save
T2C 3000 Set	PondForce 2300	£109.99	£14.98
T2C 5000 Set	PondForce 3000	£129.99	£24.98
T2C 9000 Set NEW	PondForce 4700	£149.99	£34.98
T2C 12000 Set NEW	PondForce 6200	£179.99	£34.98



NEW

SPRING
Sale

PondXpert VariSmart Pumps

Variable flow pumps with advanced on-board electronic intelligence (SmartPump Technology)

- Ten minute Pause/feeding function
- Lockable flow setting positions
- Auto-off with blockage protection
- Audible alarm if blockage detected
- Memory function - restart position



Model	Flow Rate	Power Use	Height	Hose	RRP	Post Event Price	OUR PRICE
VariSmart 8000	3500-8000 lph	18 - 80 Watts	5.4m	20/25/32	£299.99	£149.99	£129.99
VariSmart 15000	7500-15000 lph	37 - 180 Watts	7.0m	25/32/40	£399.99	£199.99	£169.99

Adjustable Flow Rate

10 different rates of flow



Run at half capacity and reduce running cost 75%

VariSmart 8000				VariSmart 15000			
Gear	Power	Flow	H-max	Gear	Power	Flow	H-max
SP01	18W	3500L/H	1.6m	SP01	37W	7500L/H	2.5m
SP02	23W	4000L/H	1.9m	SP02	47W	8500L/H	2.7m
SP03	28W	4600L/H	2.3m	SP03	61W	9200L/H	3.2m
SP04	35W	5000L/H	2.7m	SP04	77W	10000L/H	3.7m
SP05	42W	5400L/H	3.2m	SP05	97W	11000L/H	4.3m
SP06	51W	5800L/H	3.5m	SP06	110W	11500L/H	4.9m
SP07	60W	6200L/H	3.9m	SP07	124W	12000L/H	5.4m
SP09	73W	7200L/H	4.5m	SP09	142W	12700L/H	6m
SP08	66W	6700L/H	4.8m	SP08	157W	13500L/H	6.5m
SP10	80W	8000L/H	5.4m	SP10	180W	15000L/H	7m

Pump Flow Curves

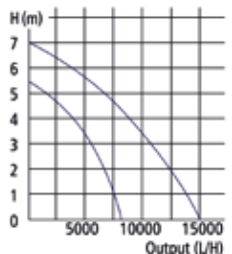

Price Breakthrough

Professional variable flow technology now available to the ornamental pond owner

3 Year Guarantee 10m power cable Dimensions (LWH) 8000 19 x 11x 12cm 15000 21 x 12 x 14cm

